

# ST RC241S...RC246S

## NPN Silicon Epitaxial Planar Transistor

for high current switching, interface circuit and driver circuit application.

- With built-in bias resistor
- Simplify circuit design
- Reduce a quantity of parts and manufacturing process

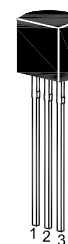
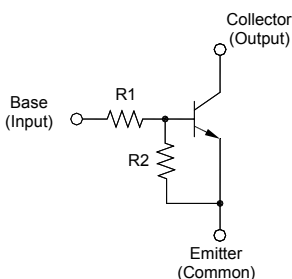

1. Emitter 2. Collector 3. Base  
TO-92 Plastic Package

### Resistor Values

Type	R1 (KΩ)	R2 (KΩ)
RC241S	1	1
RC242S	2.2	2.2
RC243S	4.7	4.7
RC244S	10	10
RC245S	1	10
RC246S	2.2	10

### Absolute Maximum Ratings ( $T_a = 25\text{ }^\circ\text{C}$ )

Parameter		Symbol	Value	Unit
Output Voltage		$V_o$	50	V
Input Voltage	RC241S	$V_i$	10, -10	V
	RC242S		12, -10	
	RC243S		20, -10	
	RC244S		30, -10	
	RC245S		10, -5	
	RC246S		12, -6	
Output Current		$I_o$	300	mA
Total Power Dissipation		$P_{tot}$	200	mW
Junction Temperature		$T_j$	150	$^\circ\text{C}$
Storage Temperature Range		$T_{stg}$	- 55 to + 150	$^\circ\text{C}$

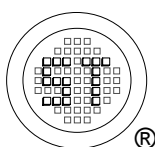

**SEMTECH ELECTRONICS LTD.**  
Subsidiary of Sino-Tech International (BVI) Limited



# ST RC241S...RC246S

## Characteristics at $T_a = 25\text{ }^\circ\text{C}$

Parameter	Symbol	Min.	Typ.	Max.	Unit
DC Current Gain at $V_O = 5\text{ V}$ , $I_O = 50\text{ mA}$	RC241S	33	-	-	-
	RC242S	39	-	-	-
	RC243S	47	-	-	-
	RC244S	56	-	-	-
	RC245S	56	-	-	-
	RC246S	56	-	-	-
Output Cutoff Current at $V_O = 30\text{ V}$	$I_{O(OFF)}$	-	-	10	$\mu\text{A}$
Input Current at $V_I = 5\text{ V}$	RC241S	-	-	7.2	mA
	RC242S	-	-	3.8	
	RC243S	-	-	1.8	
	RC244S	-	-	0.88	
	RC245S	-	-	7.2	
	RC246S	-	-	3.6	
Output Voltage at $I_O = 10\text{ mA}$ , $I_I = 0.5\text{ mA}$	$V_{O(ON)}$	-	-	0.3	V
Input Voltage (ON) at $V_O = 0.3\text{ V}$ , $I_O = 20\text{ mA}$	RC241S	-	-	3	V
	RC242S	-	-	3	
	RC243S	-	-	3	
	RC244S	-	-	3	
	RC245S	-	-	3	
	RC246S	-	-	2	
Input Voltage (OFF) at $V_O = 5\text{ V}$ , $I_O = 0.1\text{ mA}$	RC241S~244S	$-V_{I(OFF)}$	0.5	-	V
	RC245S~246S		0.3	-	
Transition Frequency at $V_O = 10\text{ V}$ , $I_O = 5\text{ mA}$ , $f = 100\text{ MHz}$	$f_T$ <sup>1)</sup>	-	200	-	MHz

<sup>1)</sup> Characteristic of transistor only.

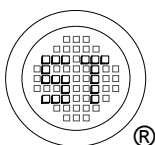

**SEMTECH ELECTRONICS LTD.**  
Subsidiary of Sino-Tech International (BVI) Limited



Dated : 30/10/2010 Rev:02

# ST RC241S...RC246S

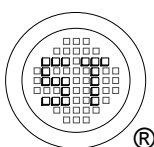
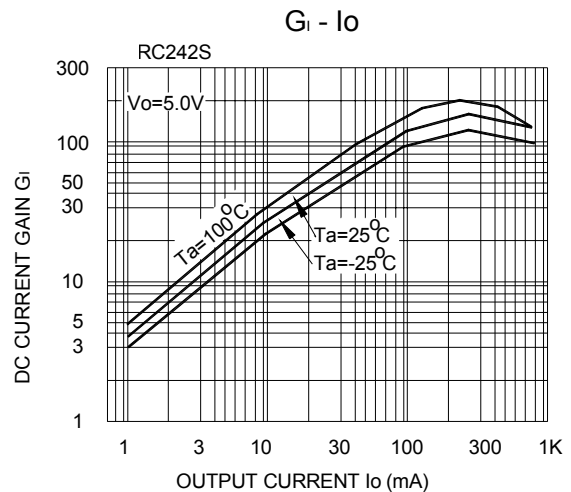
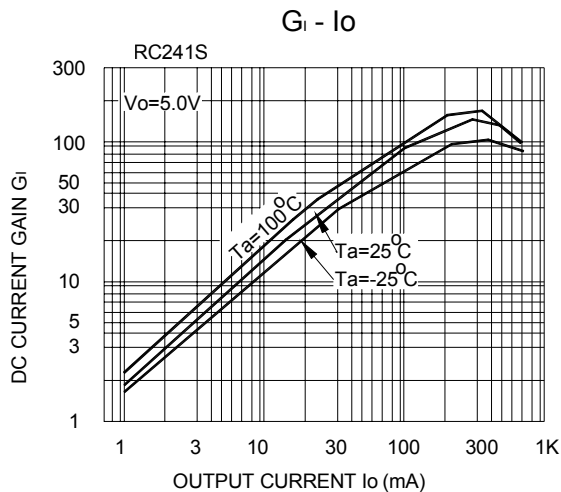
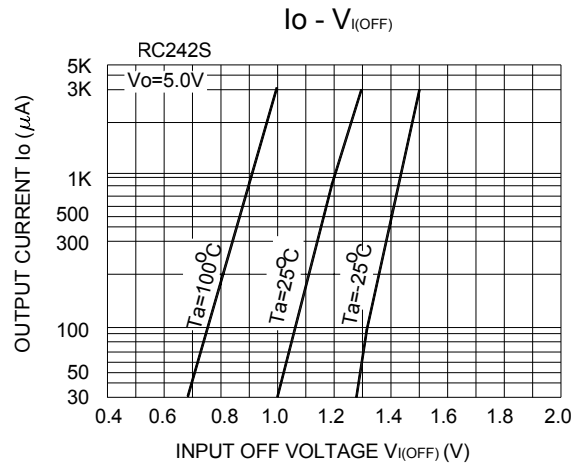
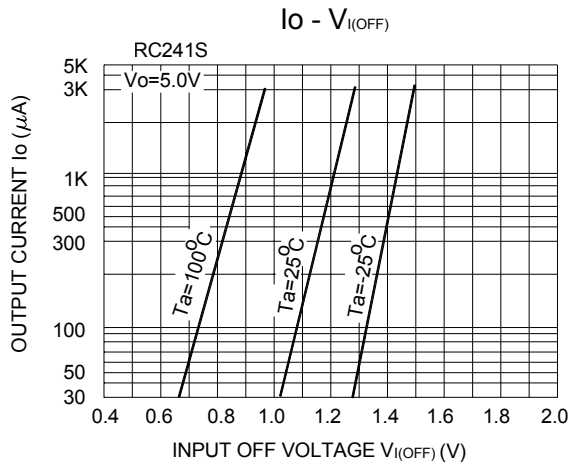
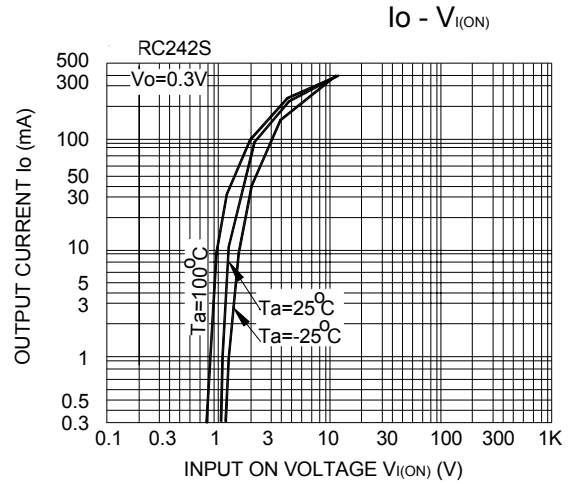
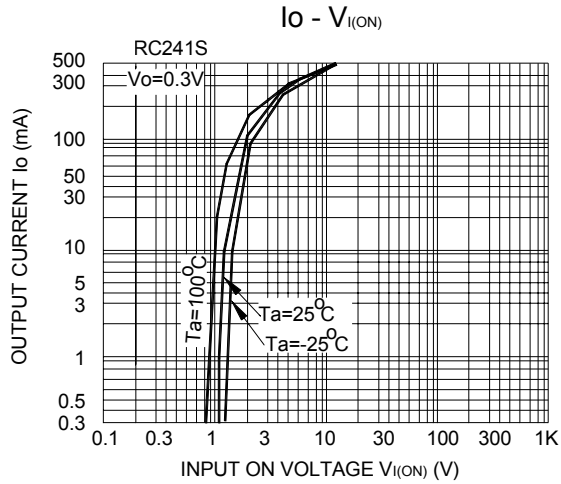

**SEMTECH ELECTRONICS LTD.**  
Subsidiary of Sino-Tech International (BVI) Limited



# ST RC241S...RC246S

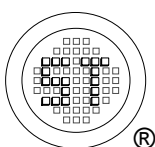
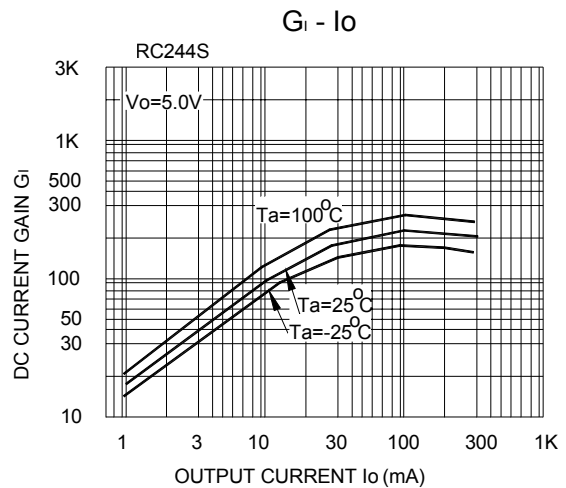
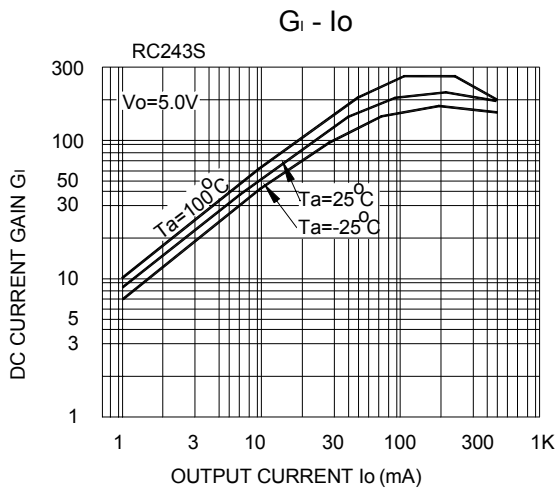
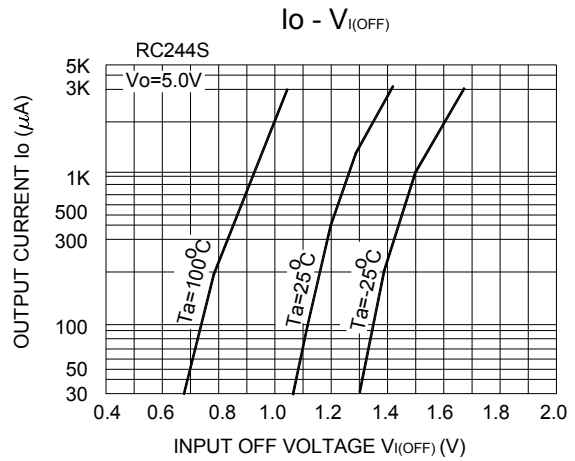
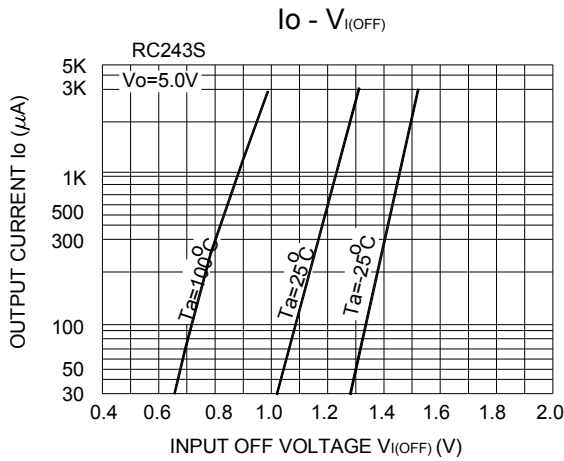
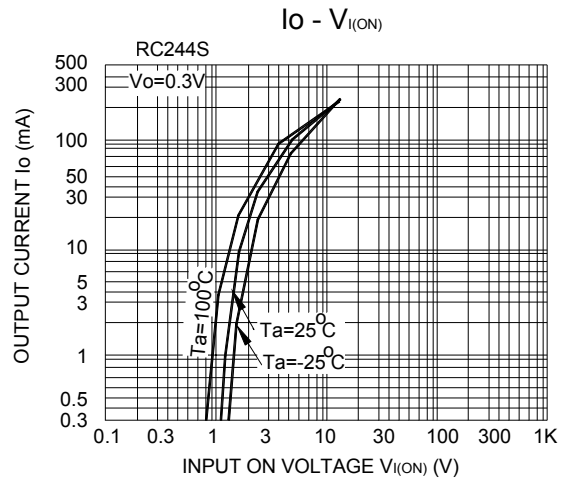
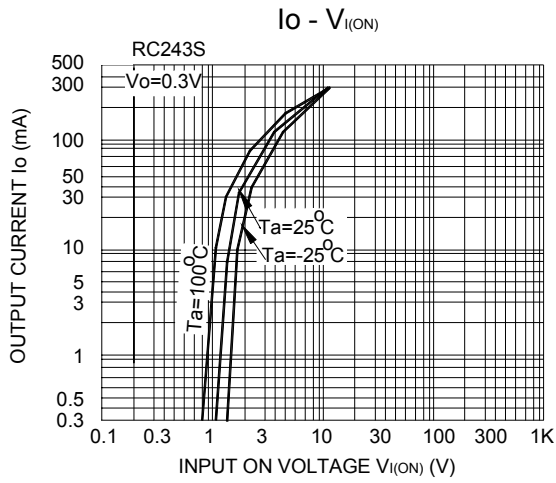

**SEMTECH ELECTRONICS LTD.**  
Subsidiary of Sino-Tech International (BVI) Limited



# ST RC241S...RC246S

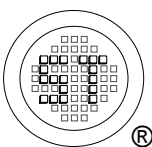
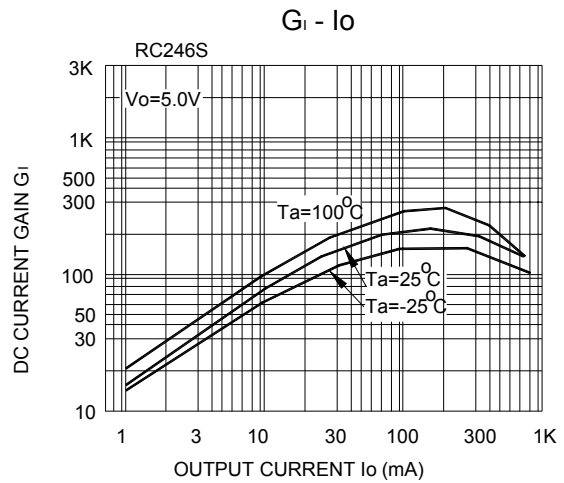
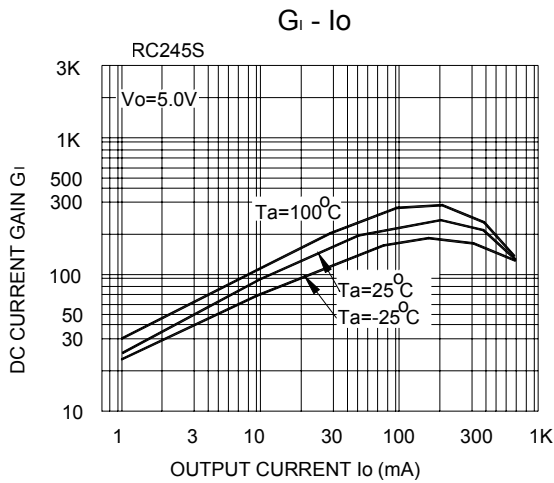
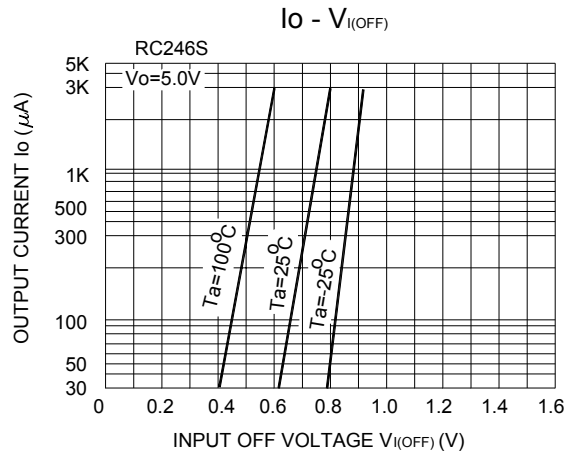
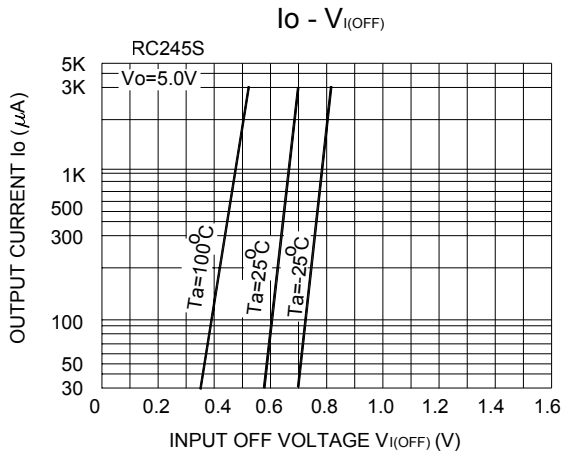
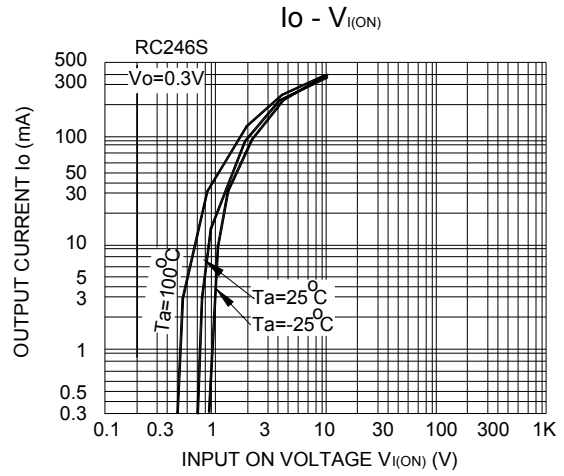
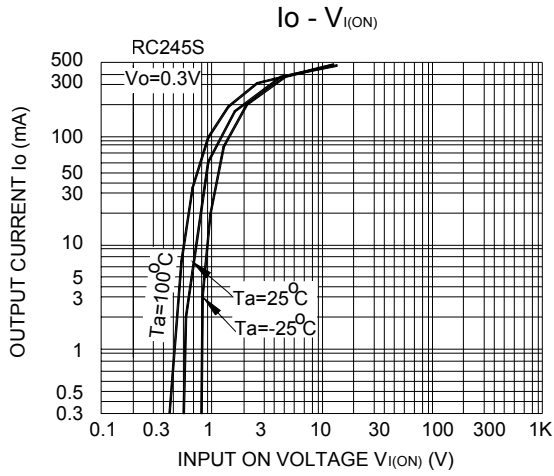

**SEMTECH ELECTRONICS LTD.**  
Subsidiary of Sino-Tech International (BVI) Limited

