

ST RA221S...RA226S

PNP Silicon Epitaxial Planar Transistors

for high current switching, interface circuit and driver circuit application.

Feature

- With Built-in Bias Resistor
- Simplify Circuit Design
- Reduce a Quantity of Parts and Manufacturing Process

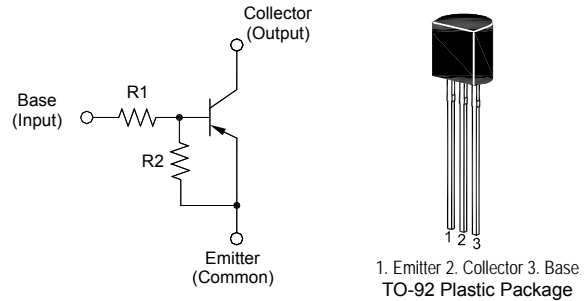

Resistor Values

Type	R1 (KΩ)	R2 (KΩ)
RA221S	1	1
RA222S	2.2	2.2
RA223S	4.7	4.7
RA224S	10	10
RA225S	1	10
RA226S	2.2	10

Absolute Maximum Ratings ($T_a = 25^\circ\text{C}$)

Parameter	Symbol	Value	Unit
Output Voltage	$-V_o$	50	V
Input Voltage	$-V_i$	10, -10	V
		12, -10	
		20, -10	
		30, -10	
		10, -5	
		12, -6	
Output Current	$-I_o$	300	mA
Total Power Dissipation	P_{tot}	200	mW
Junction Temperature	T_j	150	$^\circ\text{C}$
Storage Temperature Range	T_{stg}	- 55 to + 150	$^\circ\text{C}$

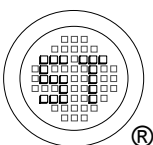

SEMTECH ELECTRONICS LTD.
Subsidiary of Sino-Tech International (BVI) Limited



ST RA221S...RA226S

Characteristics at $T_a = 25\text{ }^\circ\text{C}$

Parameter	Symbol	Min.	Typ.	Max.	Unit
DC Current Gain at $-V_o = 5\text{ V}$, $-I_o = 50\text{ mA}$	RA221S	33	-	-	-
	RA222S	39	-	-	-
	RA223S	47	-	-	-
	RA224S	56	-	-	-
	RA225S	56	-	-	-
	RA226S	56	-	-	-
Output Cutoff Current at $-V_o = 30\text{ V}$	$-I_{O(OFF)}$	-	-	10	μA
Input Current at $-V_i = 5\text{ V}$	RA221S	-	-	7.2	mA
	RA222S	-	-	3.8	
	RA223S	-	-	1.8	
	RA224S	-	-	0.88	
	RA225S	-	-	7.2	
	RA226S	-	-	3.6	
Output Voltage at $-I_o = 10\text{ mA}$, $-I_i = 0.5\text{ mA}$	$-V_{O(ON)}$	-	-	0.3	V
Input Voltage (ON) at $-V_o = 0.3\text{ V}$, $-I_o = 20\text{ mA}$	RA221S	-	-	3	V
	RA222S	-	-	3	
	RA223S	-	-	3	
	RA224S	-	-	3	
	RA225S	-	-	3	
	RA226S	-	-	2	
Input Voltage (OFF) at $-V_o = 5\text{ V}$, $-I_o = 0.1\text{ mA}$	RA221S~224S	$-V_{I(OFF)}$	0.5	-	V
	RA225S~226S		0.3	-	
Transition Frequency at $-V_o = 10\text{ V}$, $-I_o = 5\text{ mA}$, $f = 100\text{ MHz}$	f_T ¹⁾	-	200	-	MHz

¹⁾ Characteristic of transistor only.

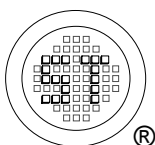

SEMTECH ELECTRONICS LTD.
Subsidiary of Sino-Tech International (BVI) Limited



Dated : 30/10/2010 Rev:02

ST RA221S...RA226S

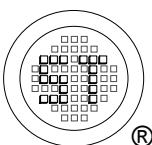
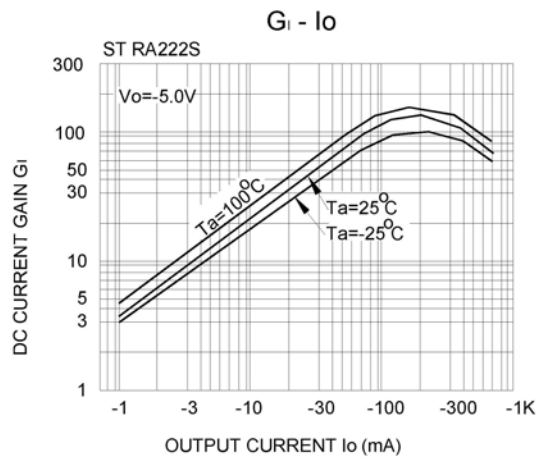
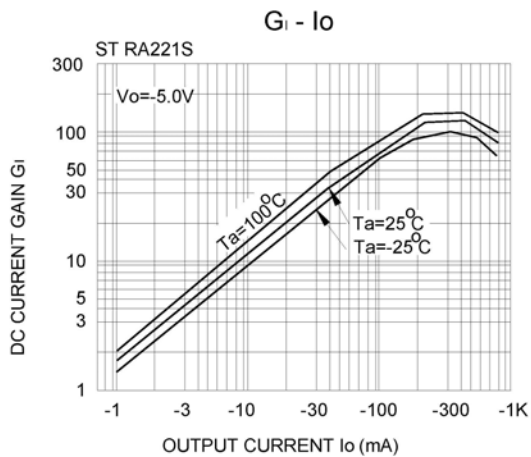
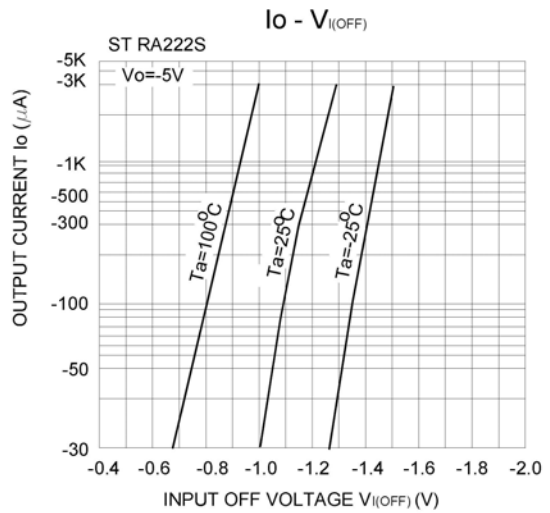
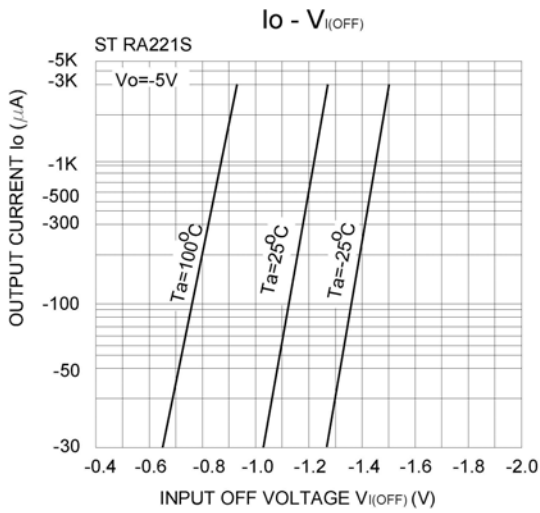
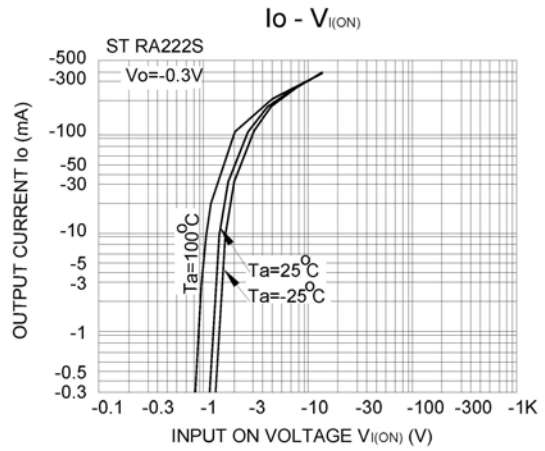
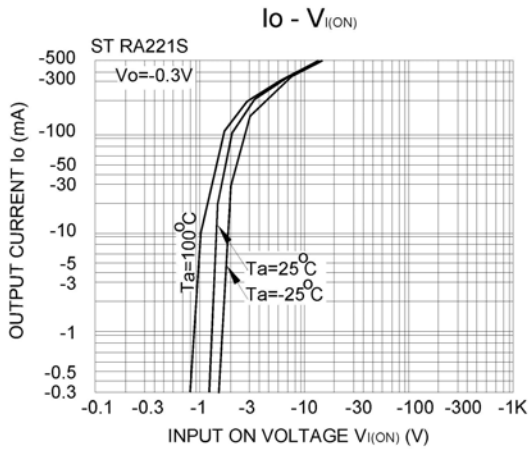

SEMTECH ELECTRONICS LTD.
 Subsidiary of Sino-Tech International (BVI) Limited



ST RA221S...RA226S

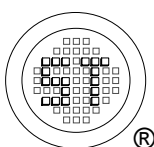
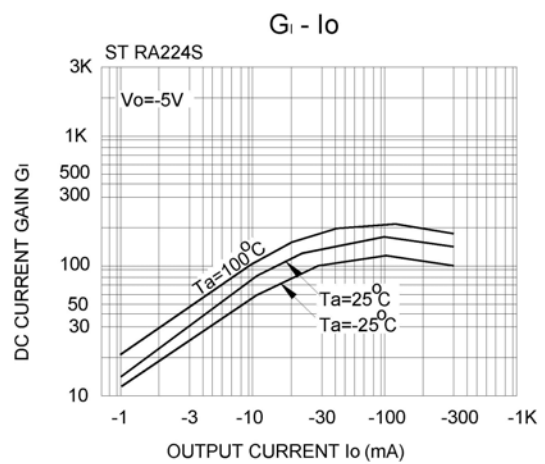
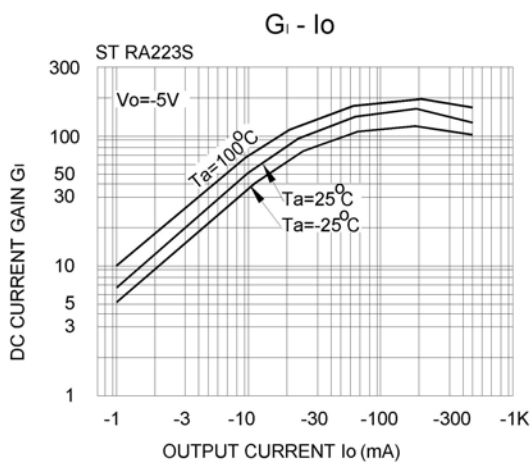
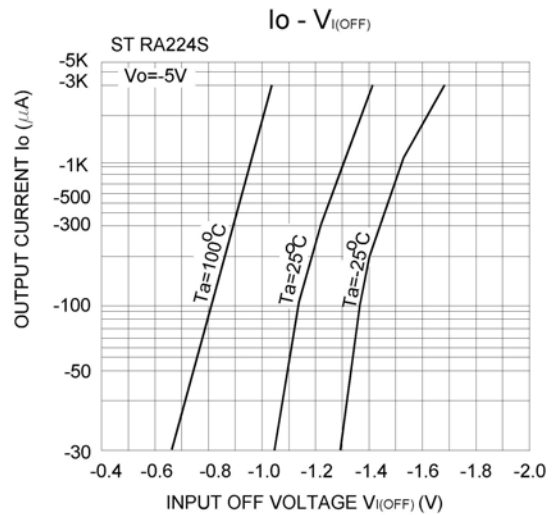
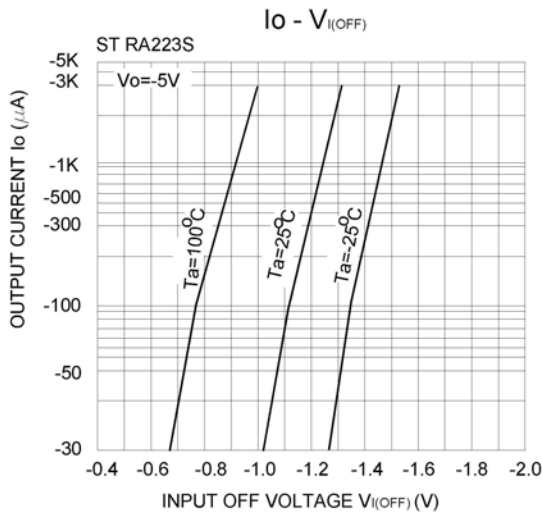
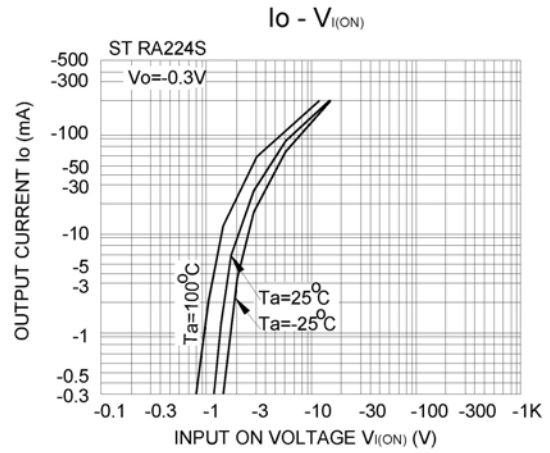
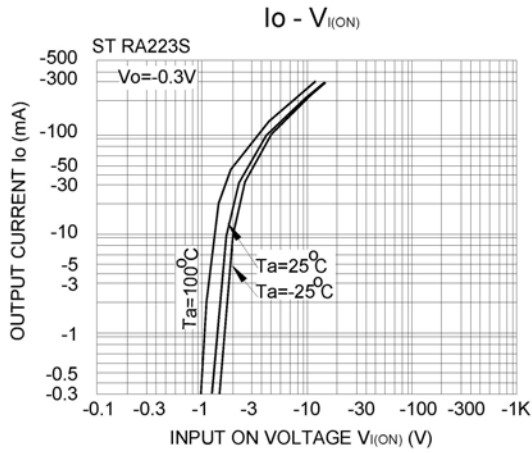

SEMTECH ELECTRONICS LTD.
 Subsidiary of Sino-Tech International (BVI) Limited



ST RA221S...RA226S

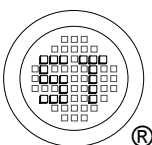
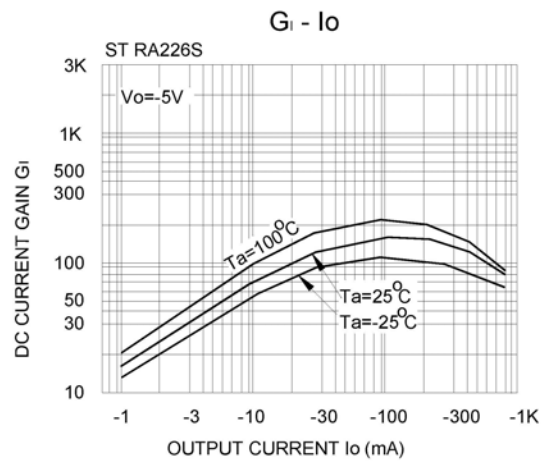
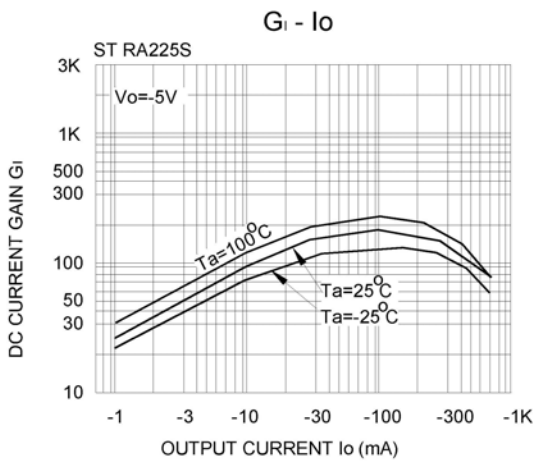
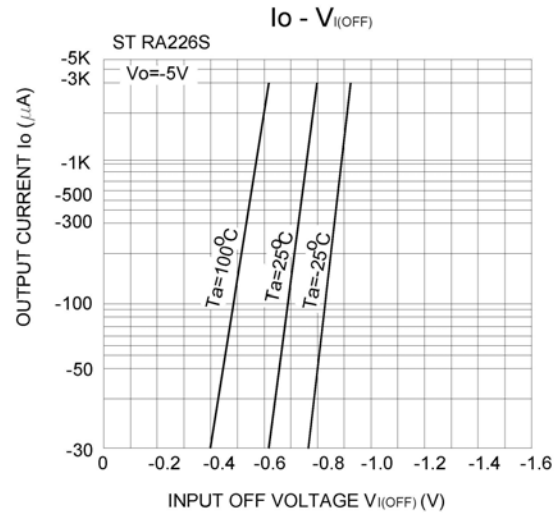
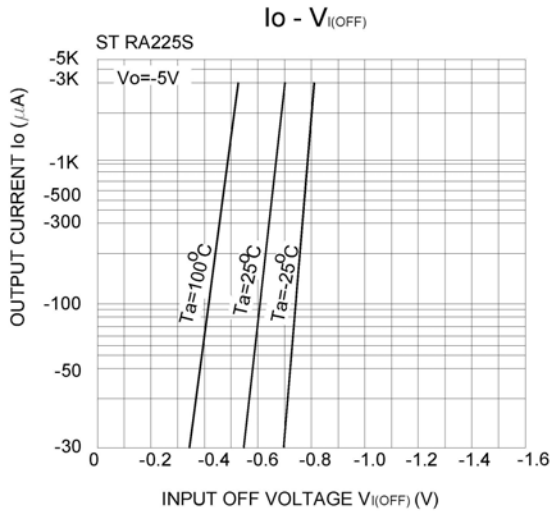
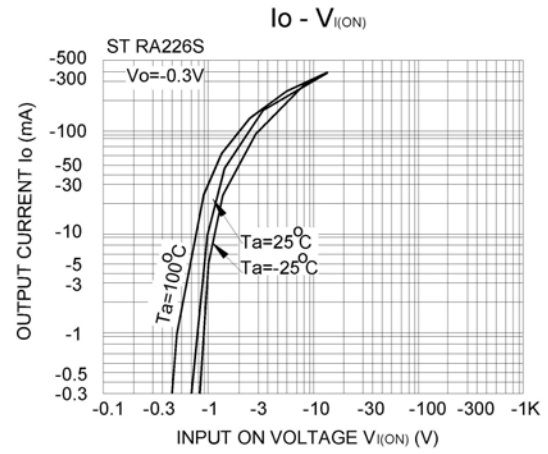
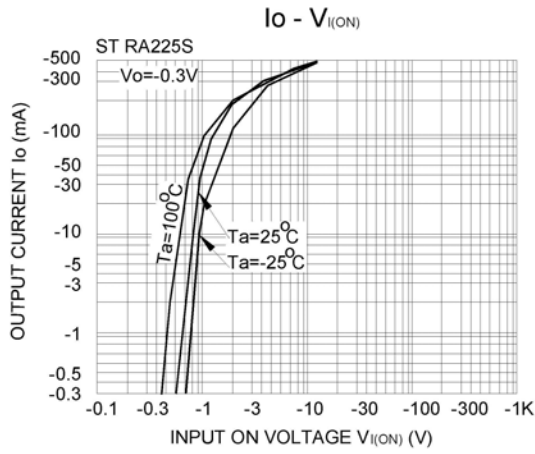

SEMTECH ELECTRONICS LTD.
Subsidiary of Sino-Tech International (BVI) Limited

