

MMBTRC241S...MMBTRC246S

NPN Silicon Epitaxial Planar Transistor

for high current switching, interface circuit and driver circuit application.

Feature

- With built-in bias resistors
- Simplify circuit design
- Reduce a quantity of parts and manufacturing process
- High output current

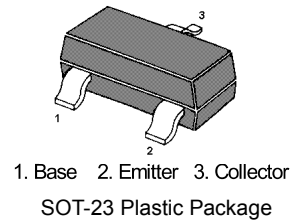
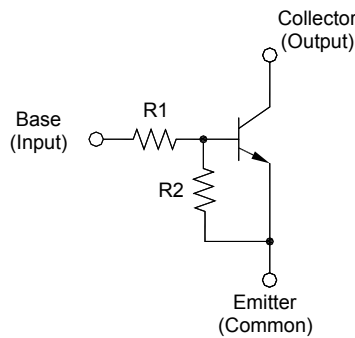

Resistor Values

Type	R1 (KΩ)	R2 (KΩ)
MMBTRC241S	1	1
MMBTRC242S	2.2	2.2
MMBTRC243S	4.7	4.7
MMBTRC244S	10	10
MMBTRC245S	1	10
MMBTRC246S	2.2	10

Absolute Maximum Ratings ($T_a = 25^\circ\text{C}$)

Parameter	Symbol	Value	Unit
Output Voltage	V_o	50	V
Input Voltage	V_i	10, -10	V
		12, -10	
		20, -10	
		30, -10	
		10, -5	
		12, -6	
Output Current	I_o	800	mA
Total Power Dissipation	P_{tot}	200	mW
Junction Temperature	T_j	150	$^\circ\text{C}$
Storage Temperature Range	T_{stg}	- 55 to + 150	$^\circ\text{C}$

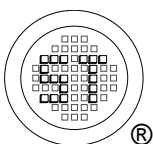

SEMTECH ELECTRONICS LTD.
Subsidiary of Sino-Tech International (BVI) Limited



MMBTRC241S...MMBTRC246S

Characteristics at $T_a = 25\text{ }^\circ\text{C}$

Parameter	Symbol	Min.	Typ.	Max.	Unit
DC Current Gain at $V_O = 5\text{ V}$, $I_O = 50\text{ mA}$	G_I	33	-	-	-
MMBTRC241S		33	-	-	-
MMBTRC242S		39	-	-	-
MMBTRC243S		47	-	-	-
MMBTRC244S		56	-	-	-
MMBTRC245S		56	-	-	-
MMBTRC246S		56	-	-	-
Output Cutoff Current at $V_O = 30\text{ V}$	$I_{O(OFF)}$	-	-	10	μA
Input Current at $V_I = 5\text{ V}$	I_I	-	-	7.2	mA
MMBTRC241S		-	-	7.2	
MMBTRC242S		-	-	3.8	
MMBTRC243S		-	-	1.8	
MMBTRC244S		-	-	0.88	
MMBTRC245S		-	-	7.2	
MMBTRC246S		-	-	3.6	
Output Voltage at $I_O = 50\text{ mA}$, $I_I = 2.5\text{ mA}$	$V_{O(ON)}$	-	-	0.3	V
Input Voltage (ON) at $V_O = 0.3\text{ V}$, $I_O = 20\text{ mA}$	$V_{I(ON)}$	-	-	3	V
MMBTRC241S		-	-	3	
MMBTRC242S		-	-	3	
MMBTRC243S		-	-	3	
MMBTRC244S		-	-	3	
MMBTRC245S		-	-	3	
MMBTRC246S		-	-	2	
Input Voltage (OFF) at $V_O = 5\text{ V}$, $I_O = 0.1\text{ mA}$	$-V_{I(OFF)}$	0.5	-	-	V
MMBTRC241S~244S		0.5	-	-	
MMBTRC245S~246S		0.3	-	-	
Transition Frequency at $V_O = 10\text{ V}$, $I_O = 5\text{ mA}$, $f = 100\text{ MHz}$	$f_T^{1)}$	-	200	-	MHz

¹⁾ Characteristic of transistor only.

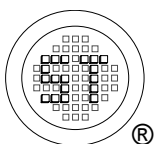

SEMTECH ELECTRONICS LTD.
Subsidiary of Sino-Tech International (BVI) Limited



Dated : 19/10/2010 Rev:01

MMBTRC241S...MMBTRC246S

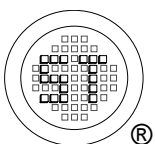
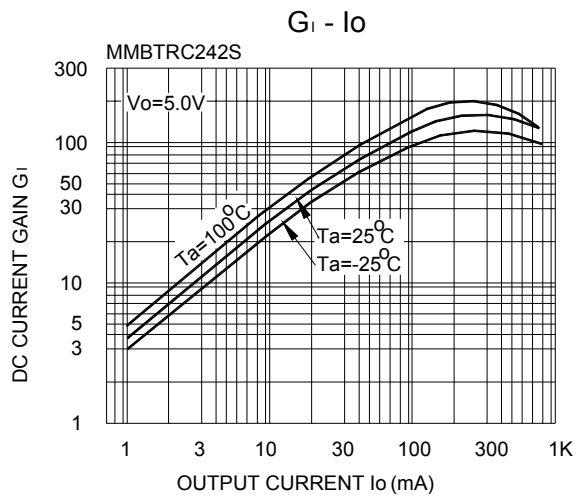
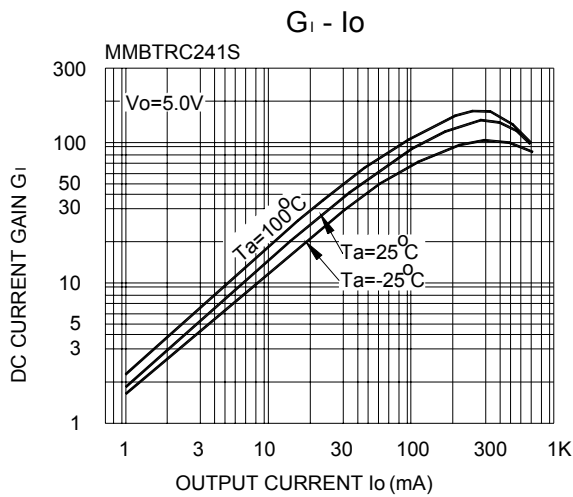
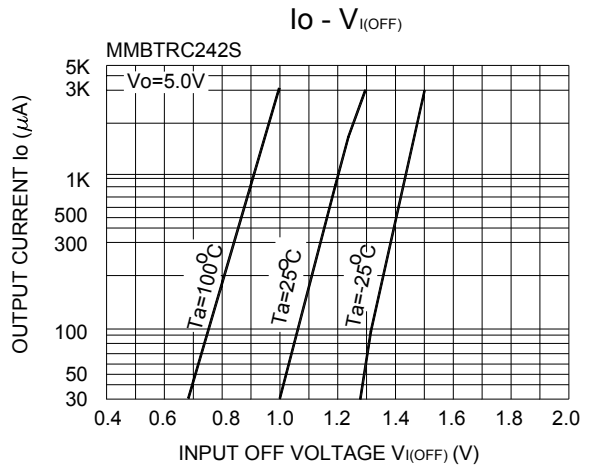
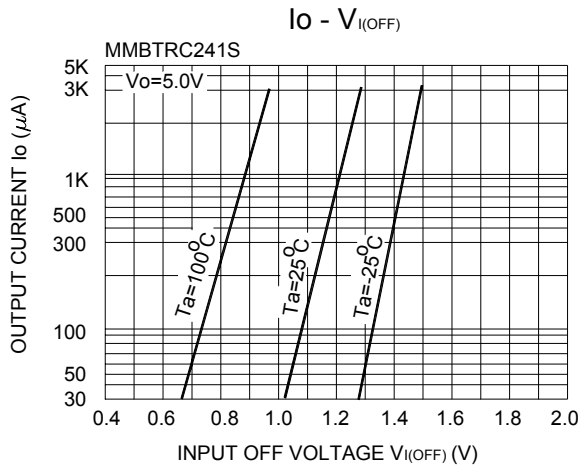
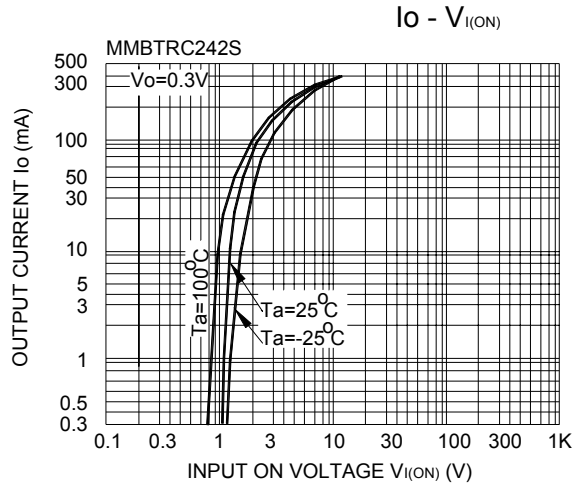
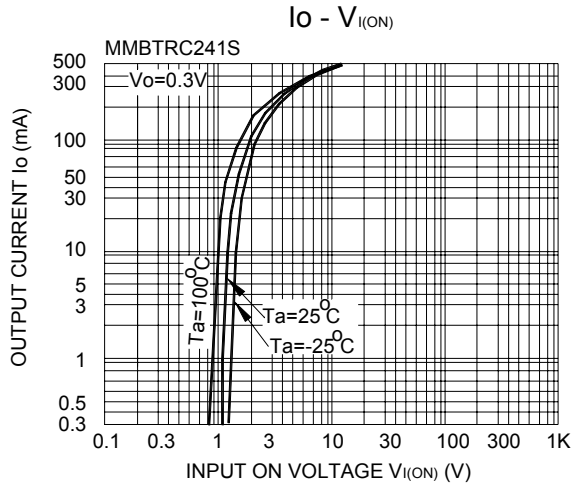

SEMTECH ELECTRONICS LTD.
Subsidiary of Sino-Tech International (BVI) Limited



MMBTRC241S...MMBTRC246S

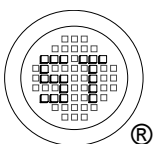
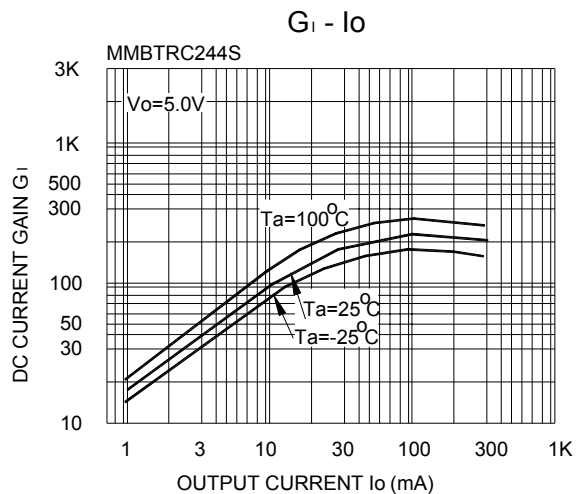
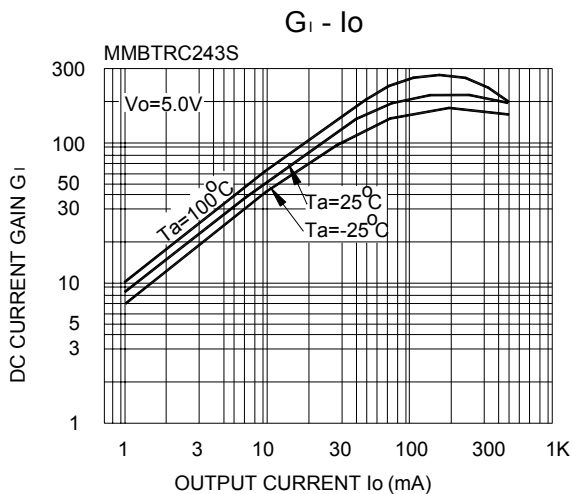
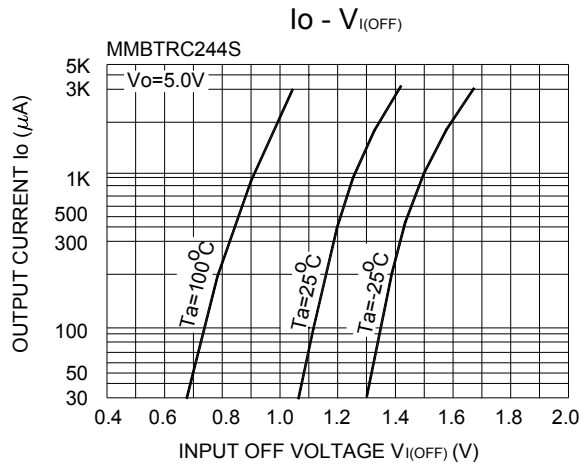
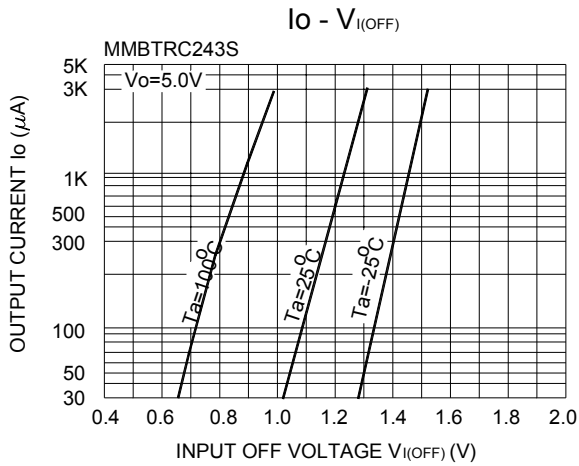
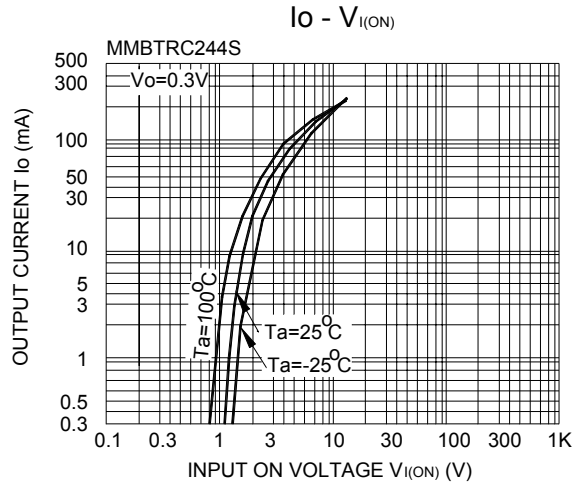
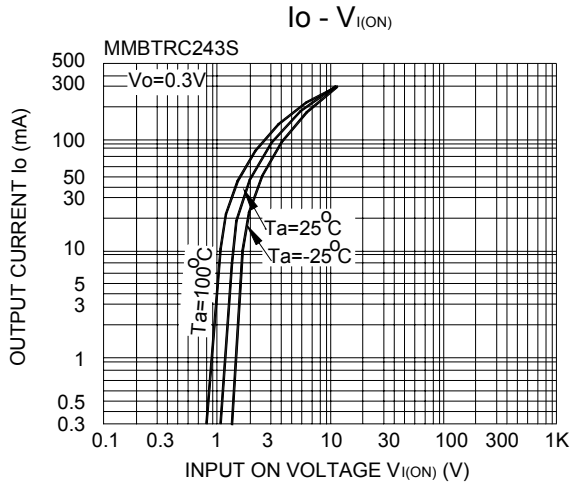

SEMTECH ELECTRONICS LTD.
Subsidiary of Sino-Tech International (BVI) Limited



MMBTRC241S...MMBTRC246S

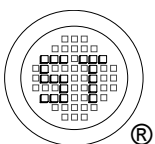
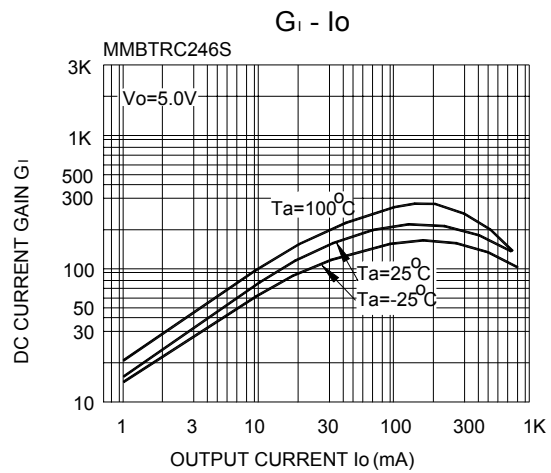
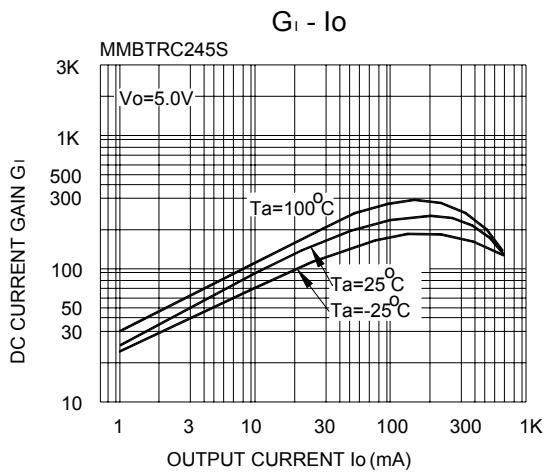
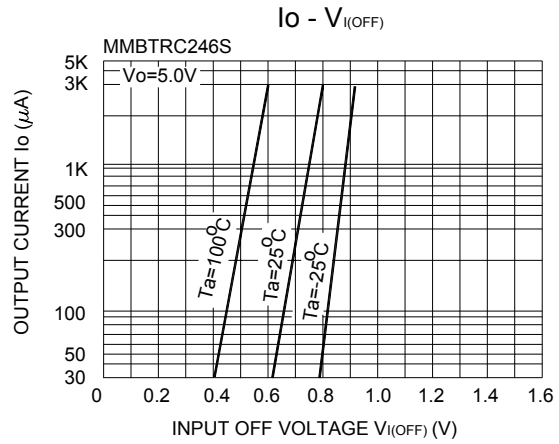
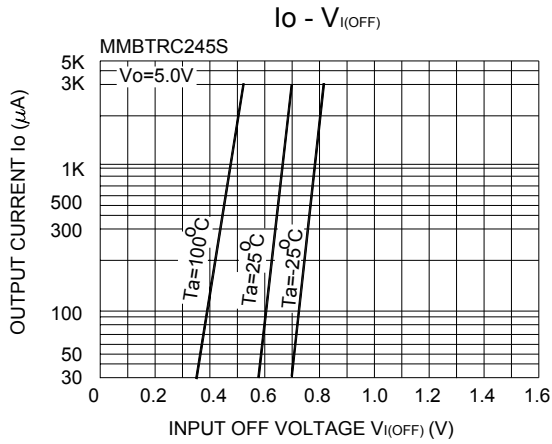
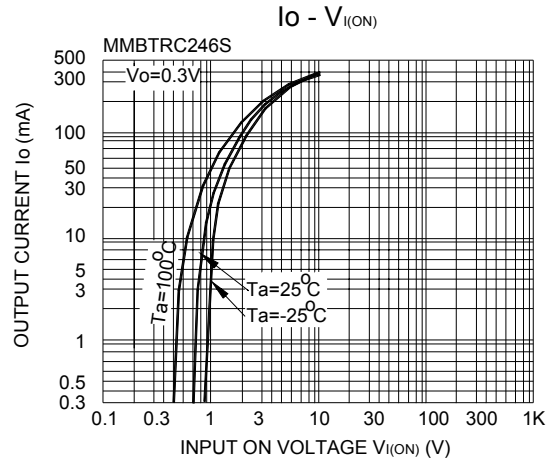
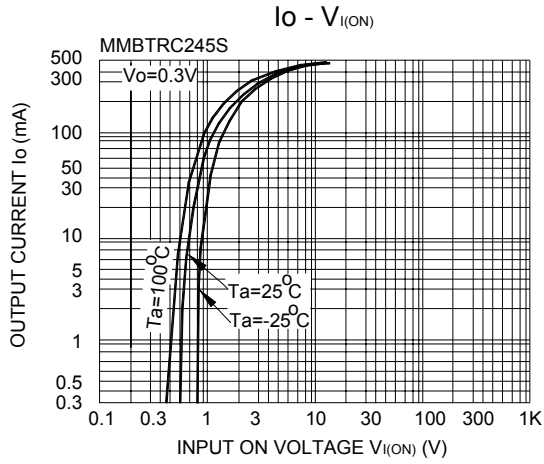

SEMTECH ELECTRONICS LTD.
Subsidiary of Sino-Tech International (BVI) Limited

