

MUR1620CT

GLASS PASSIVATED HIGH EFFICIENCY RECTIFIER

TO-220

Reverse Voltage – 50 to 1000 Volts

Forward Current – 16.0 Amperes

Features

- Low forward voltage, High current capability
- Plastic package has Underwriters Laboratory Flammability Classification 94V-O utilizing Flame Retardant Epoxy Molding Compound.
- High surge capacity
- Low power loss, high efficiency
- Ultra fast recovery times, high voltage

Mechanical Data

- **Case:** Molded plastic, TO-220
- **Terminals:** leads solderable per MIL-STD-202, method 208 guaranteed
- **Polarity:** As marked
- **Mounting Position:** Any

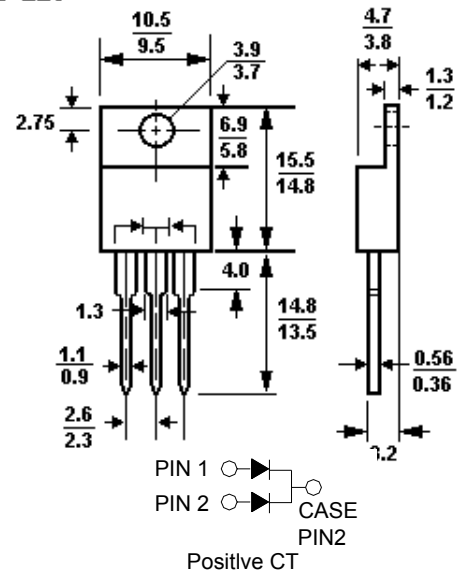

Absolute Maximum Ratings and Characteristics

Dimensions in mm

Ratings at 25°C ambient temperature unless otherwise specified. Single phase, half wave, 60Hz, resistive or inductive load. For capacitive load, derate current by 20%.

	Symbols	Value	Units
Maximum recurrent peak reverse voltage	V_{RRM}	200	Volts
Maximum RMS voltage	V_{RMS}	140	Volts
Maximum DC blocking voltage	V_{DC}	200	Volts
Maximum average forward Rectified current at $T_C = 100^\circ\text{C}$	$I_{F(AV)}$	16.0	Amps
Peak forward surge current 8.3ms single half-sine-wave superimposed on rated load (JEDEC method)	I_{FSM}	125	Amps
Maximum forward voltage at 8.0A and $T_A = 25^\circ\text{C}$	V_F	1.0	Volts
Typical junction Capacitance (Note1)	C_J	80	pF
Maximum reverse recovery time (Note 2)	T_{RR}	50	nS
Typical thermal resistance (Note3)	$R_{\theta JC}$	3.0	$^\circ\text{C}/\text{W}$
Maximum reverse current at rated DC blocking voltage	@ $T_A = 25^\circ\text{C}$	10	μAmps
	@ $T_C = 125^\circ\text{C}$	500	μAmps
Operating and storage temperature range	T_J, T_s	-55 to +150	$^\circ\text{C}$

Notes :1. Measured at 1 MHz and applied reverse voltage of 4.0 VDC.

2. Reverse recovery test conditions: $I_F = 0.5\text{A}$, $I_R = 1\text{A}$, $I_{RR} = 0.25\text{A}$

3. Thermal resistance from junction to case per leg mounted on heatsink.

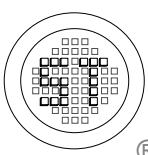

SEMTECH ELECTRONICS LTD.

(Subsidiary of Semtech International Holdings Limited, a company listed on the Hong Kong Stock Exchange, Stock Code: 724)

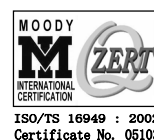

ISO/TS 16949 : 2002 Certificate No. 05103

ISO 14001 Certificate No. 7116

ISO 9001 : 2000 Certificate No. 5557-1999-0007-001

Dated : 23/06/2003

FIG.1 Reverse Recovery Time Characteristic and Test Circuit Diagram

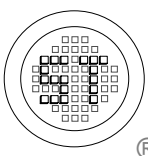
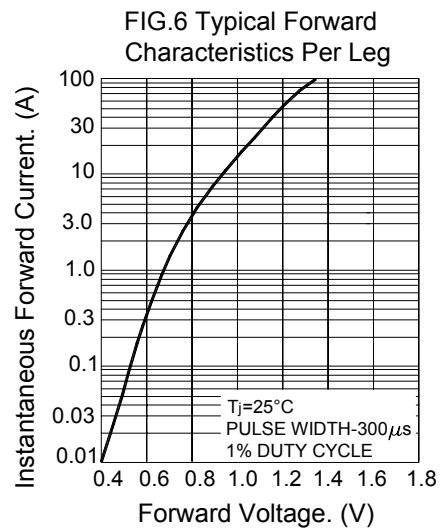
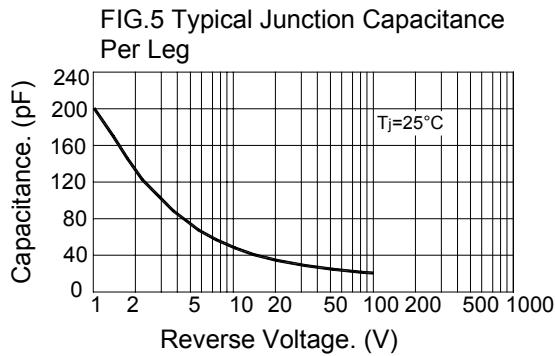
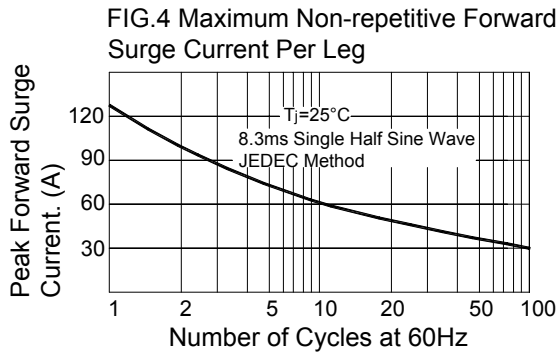
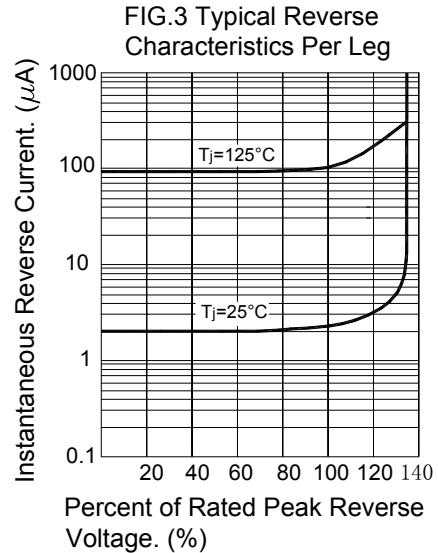
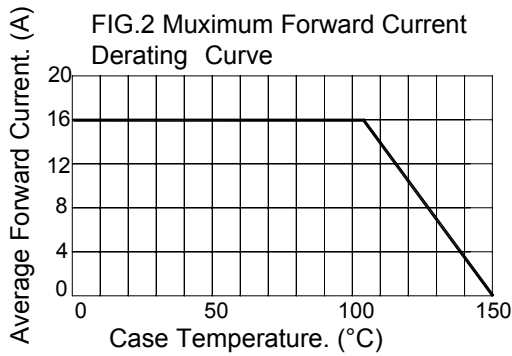
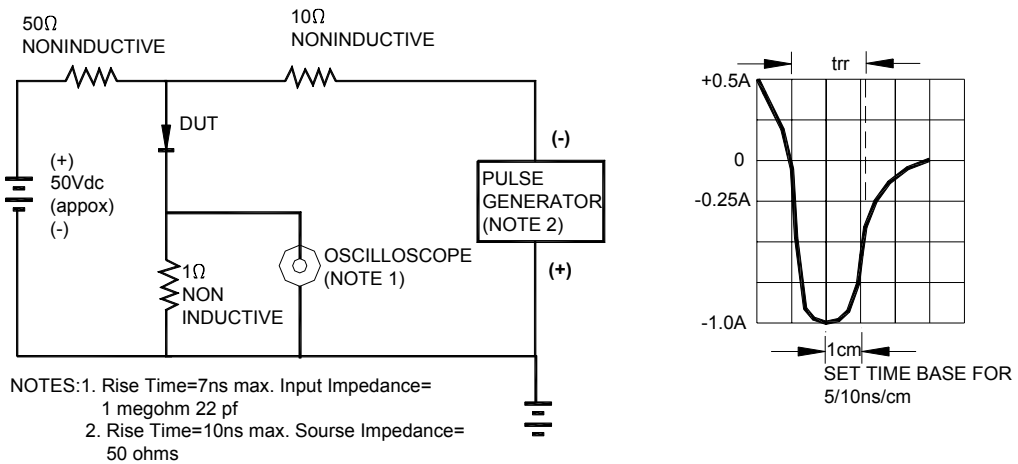

SEMTECH ELECTRONICS LTD.

(Subsidiary of Semtech International Holdings Limited, a company listed on the Hong Kong Stock Exchange, Stock Code: 724)

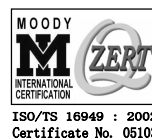

ISO/TS 16949 : 2002
Certificate No. 05103



ISO 14001
Certificate No. 7116



ISO 9001 : 2000
Certificate No. 5587-1999-0007-001