

HER151 THRU HER158

HIGH EFFICIENT RECTIFIERS
Reverse Voltage – 50 to 1000 Volts
Forward Current – 1.5 Amperes

DO-15

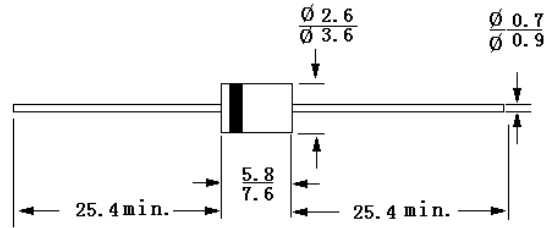

Dimensions in mm

Features

- Void-free Plastic in a DO-15 package
- 1.5 amperes operation at $T_A = 55^\circ\text{C}$ with no thermal runaway
- Ultra Fast switching for high efficiency

Mechanical Data

- Cases: Molded plastic DO-15
- Lead: Axial leads, solderable per MIL-STD-202, method 208 guaranteed
- Polarity: band denotes cathode end
- Mounting position: Any

Maximum Ratings and Electrical Characteristics

Rating at 25°C ambient temperature unless otherwise specified. Single-phase, half wave, 60Hz, resistive or inductive load.

	Symbols	HER 151	HER 152	HER 153	HER 154	HER 155	HER 156	HER 157	HER 158	Units
Maximum recurrent peak reverse voltage	V_{RRM}	50	100	200	300	400	600	800	1000	V
Maximum RMS voltage	V_{RMS}	35	70	140	210	280	420	560	700	V
Maximum DC blocking voltage	V_{DC}	50	100	200	300	400	600	800	1000	V
Maximum average forward rectified current .375"(9.5mm) lead length at $T_A = 55^\circ\text{C}$	$I_{(AV)}$	1.5								A
Peak forward surge current , 8.3mS single half sine-wave superimposed on rated load (JEDEC method)	I_{FSM}	30.0								A
Maximum instantaneous forward voltage @ 1.5A	V_F	1.0		1.3		1.7			V	
Maximum DC reverse current @ $T_A = 25^\circ\text{C}$	I_R	5.0								μA
at rated DC blocking voltage @ $T_A = 100^\circ\text{C}$	I_R	500								μA
Typical junction capacitance (Note 1)	C_J	35								pF
Maximum reverse recovery time (Note 2)	T_{rr}	50				75				nS
Typical thermal resistance (Note3)	$R_{\theta JA}$	45.0								$^\circ\text{C/W}$
Operating temperature range	T_J	-55 to +150								$^\circ\text{C}$
Storage temperature range	T_S	-55 to +150								$^\circ\text{C}$

- Note: 1. Measured at 1 MHz and applied reverse voltage of 4.0 Volts D.C.
 2. Reverse recovery test conditions: $I_F = 0.5\text{A}$, $I_R = 1.0\text{A}$, $I_{RR} = 0.25\text{A}$.
 3. Thermal Resistance from junction to ambient at 0.375" (9.5mm) lead length P.C.B. mounted.

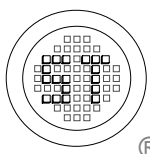

SEMTECH ELECTRONICS LTD.

(Subsidiary of Semtech International Holdings Limited, a company listed on the Hong Kong Stock Exchange, Stock Code: 724)

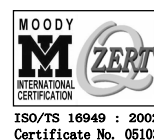

Dated : 21/03/2003

HER151 THRU HER158

RATINGS AND CHARACTERISTIC CURVES

Fig. 1-REVERSE RECOVERY TIME CHARACTERISTIC AND TEST CIRCUIT DIAGRAM

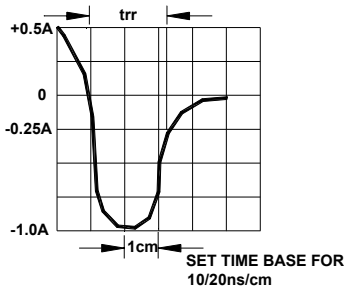
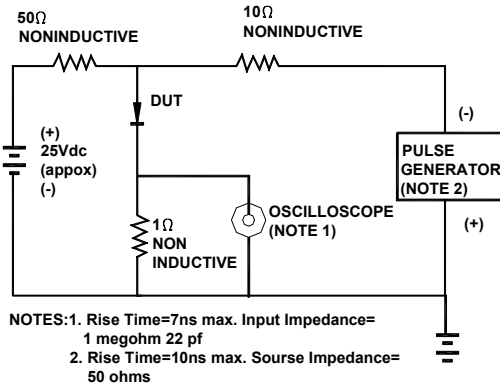

Fig.2 - TYPICAL FORWARD CURRENT DERATING

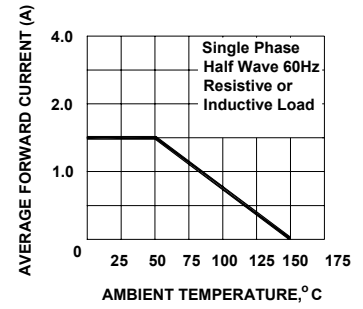

Fig. 3-TYPICAL REVERSE CHARACTERISTICS

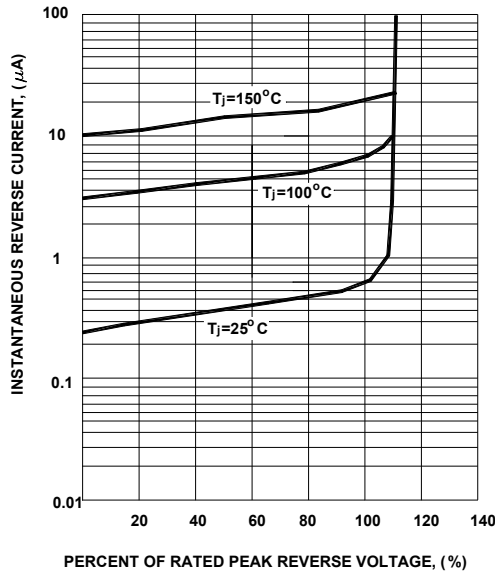

Fig. 4-TYPICAL FORWARD CHARACTERISTICS

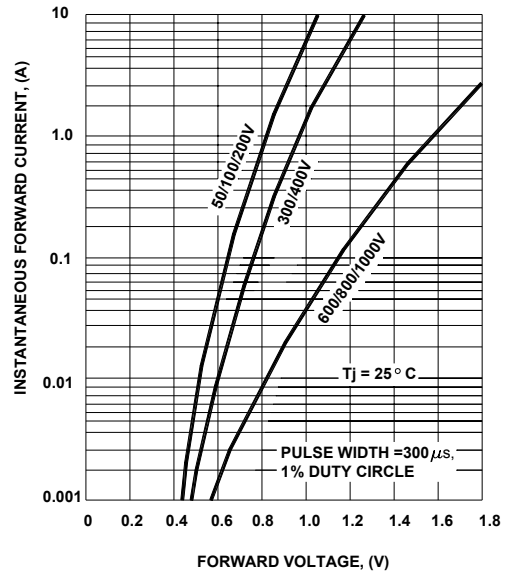

Fig. 5-MAXIMUM NON-REPETITIVE FORWARD SURGE CURRENT

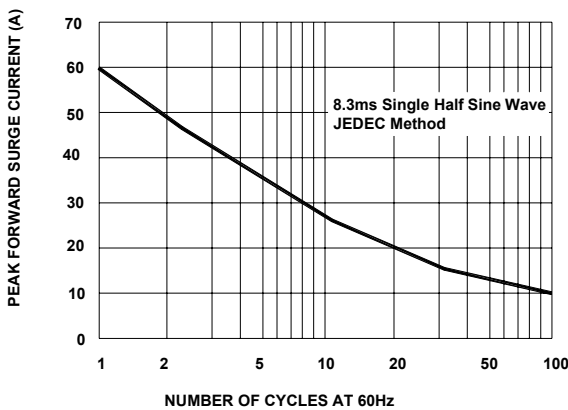
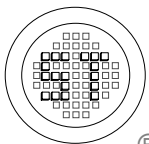
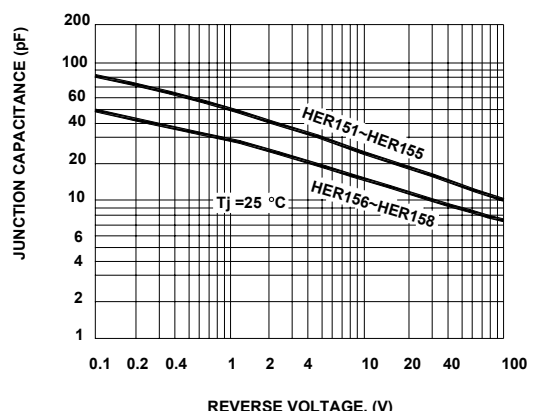
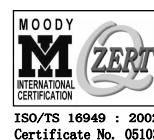

Fig. 6-TYPICAL JUNCTION CAPACITANCE



SEMTECH ELECTRONICS LTD.

(Subsidiary of Semtech International Holdings Limited, a company listed on the Hong Kong Stock Exchange, Stock Code: 724)



ISO/TS 16949 : 2002 Certificate No. 05103



ISO 14001 Certificate No. 7116



ISO 9001 : 2000 Certificate No. 250-1559-04-002-04