

1N4148WS

Silicon Epitaxial Planar Switching Diode

Features

- SOD-323 package
- Fast switching
- These diodes are also available in other case style including the DO-35 case with the type designation 1N4148, the MiniMELF case with the type designation LL4148 and the MicroMELF case with the type designation MCL4148.

PINNING

PIN	DESCRIPTION
1	Cathode
2	Anode

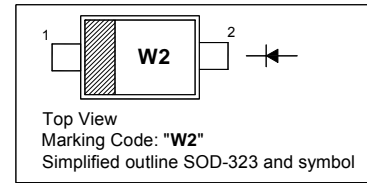

Absolute Maximum Ratings ($T_a = 25^\circ\text{C}$)

Parameter	Symbol	Value	Unit
Peak Reverse Voltage	V_{RM}	100	V
Reverse Voltage	V_R	75	V
Average Rectified Forward Current	$I_{F(AV)}$	150	mA
Surge Forward Current ($t < 1$ s, $T_j = 25^\circ\text{C}$)	I_{FSM}	350	mA
Power Dissipation	P_{tot}	200	mW
Thermal Resistance from Junction to Ambient Air	$R_{\theta JA}$	625	$^\circ\text{C/W}$
Junction Temperature	T_j	150	$^\circ\text{C}$
Storage Temperature Range	T_{stg}	- 65 to + 150	$^\circ\text{C}$

Characteristics at $T_a = 25^\circ\text{C}$

Parameter	Symbol	Min.	Max.	Unit
Reverse Breakdown Voltage at $I_R = 1 \mu\text{A}$	$V_{(BR)R}$	75	-	V
Forward Voltage at $I_F = 1$ mA at $I_F = 10$ mA at $I_F = 50$ mA at $I_F = 150$ mA	V_F	- - - -	0.715 0.855 1 1.25	V
Peak Reverse Current at $V_R = 75$ V at $V_R = 20$ V at $V_R = 75$ V, $T_j = 150^\circ\text{C}$ at $V_R = 25$ V, $T_j = 150^\circ\text{C}$	I_R	- - - -	1 25 50 30	μA nA μA μA
Total Capacitance at $V_R = 0$ V, $f = 1$ MHz	C_T	-	2	pF
Reverse Recovery Time at $I_{rr} = 0.1 \times I_R$, $I_F = I_R = 10$ mA, $R_L = 100 \Omega$	t_{rr}	-	4	ns

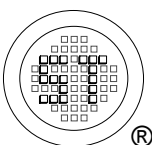

SEMTECH ELECTRONICS LTD.
Subsidiary of Sino-Tech International (BVI) Limited



Dated: 30/11/2012 Rev: 03

Forward characteristics

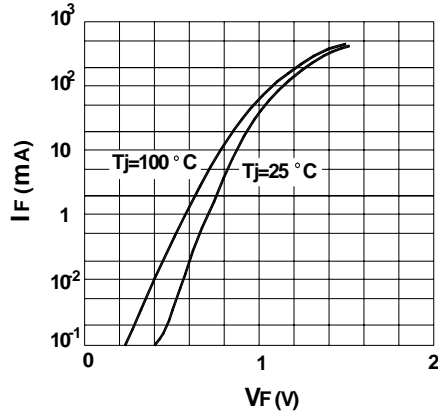

Dynamic forward resistance vs. forward current

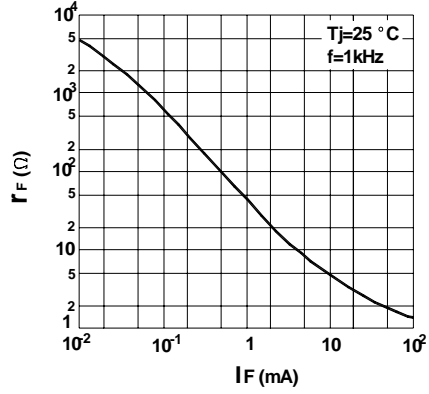

Reverse capacitance vs. reverse voltage

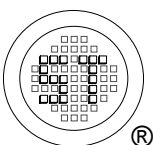
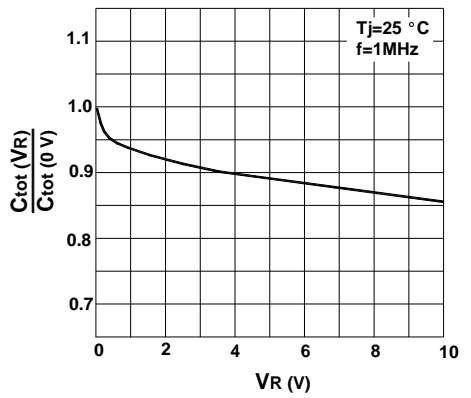

SEMTECH ELECTRONICS LTD.
 Subsidiary of Sino-Tech International (BVI) Limited



1N4148WS

PACKAGE OUTLINE

Plastic surface mounted package; 2 leads

SOD-323

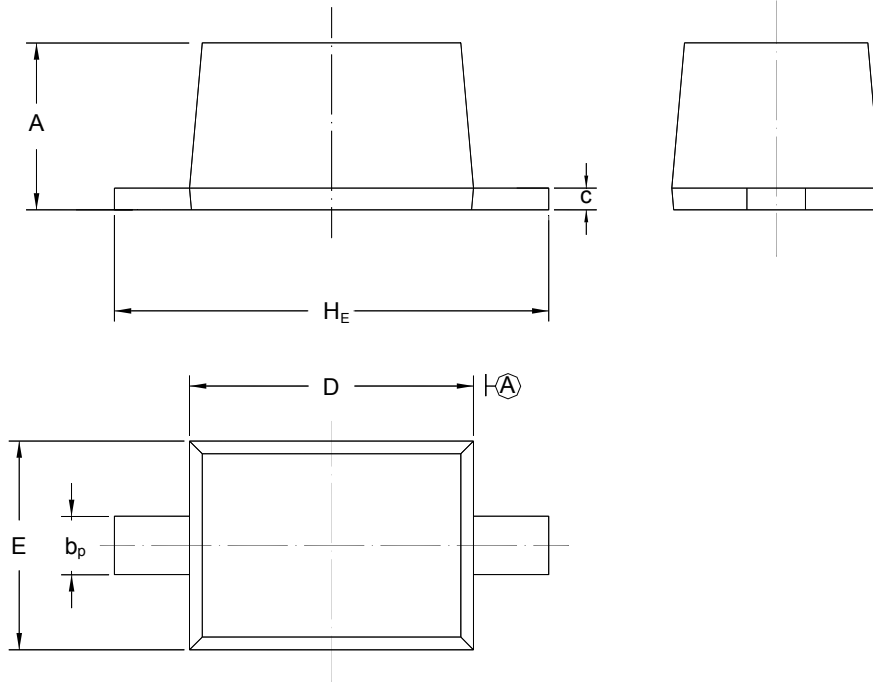

UNIT	A	b _p	C	D	E	H _E
mm	1.10 0.80	0.40 0.25	0.15 0.10	1.80 1.60	1.35 1.15	2.80 2.30

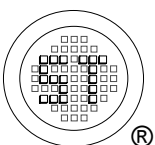

SEMTECH ELECTRONICS LTD.
Subsidiary of Sino-Tech International (BVI) Limited



Dated: 30/11/2012 Rev: 03