

SDB412WS

SILICON EPITAXIAL PLANAR SCHOTTKY BARRIER DIODE

Features

- Small surface mounting type
- Low forward voltage
- High reliability

Applications

- Low power rectification

PINNING

PIN	DESCRIPTION
1	Cathode
2	Anode

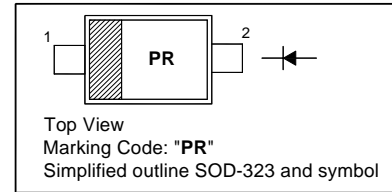

Absolute Maximum Ratings ($T_a = 25\text{ }^\circ\text{C}$)

Parameter	Symbol	Value	Unit
Peak Reverse Voltage	V_{RM}	40	V
Reverse Voltage	V_R	20	V
Average Forward Current	I_O	0.5	A
Peak Forward Surge Current	I_{FSM}	3	A
Junction Temperature	T_j	125	$^\circ\text{C}$
Storage Temperature Range	T_{stg}	- 40 to + 125	$^\circ\text{C}$

Characteristics at $T_a = 25\text{ }^\circ\text{C}$

Parameter	Symbol	Typ.	Max.	Unit
Forward Voltage at $I_F = 10\text{ mA}$ at $I_F = 500\text{ mA}$	V_F	- -	0.3 0.5	V
Reverse Current at $V_R = 10\text{ V}$ at $V_R = 40\text{ V}$	I_R	- -	30 200	μA
Total Capacitance at $V_R = 10\text{ V}$, $f = 1\text{ MHz}$	C_T	20	-	pF

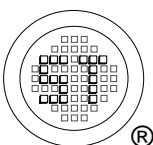

SEMTECH ELECTRONICS LTD.
Subsidiary of Sino-Tech International (BVI) Limited



Dated : 01/09/2006

SDB412WS

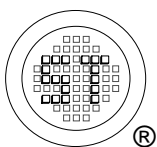
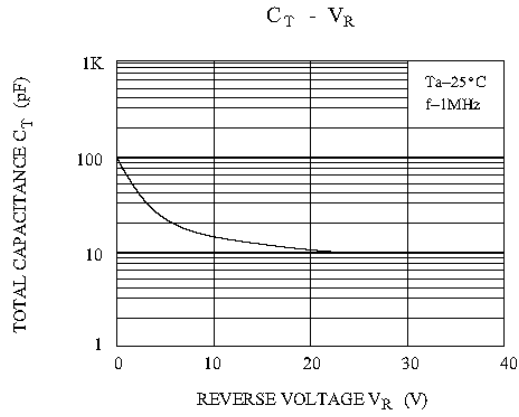
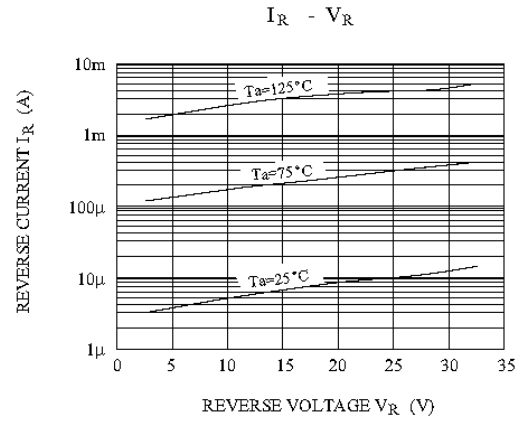
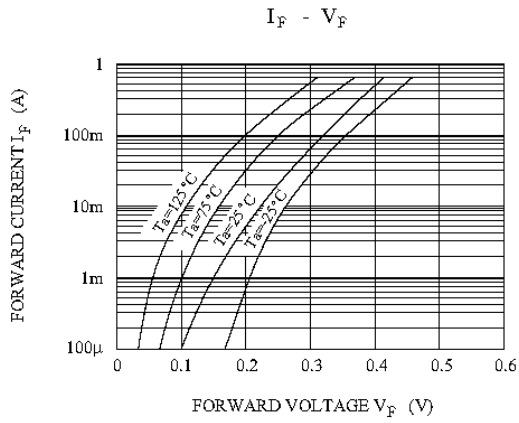

SEMTECH ELECTRONICS LTD.
 Subsidiary of Sino-Tech International (BVI) Limited



Dated : 01/09/2006

SDB412WS

PACKAGE OUTLINE

Plastic surface mounted package; 2 leads

SOD-323

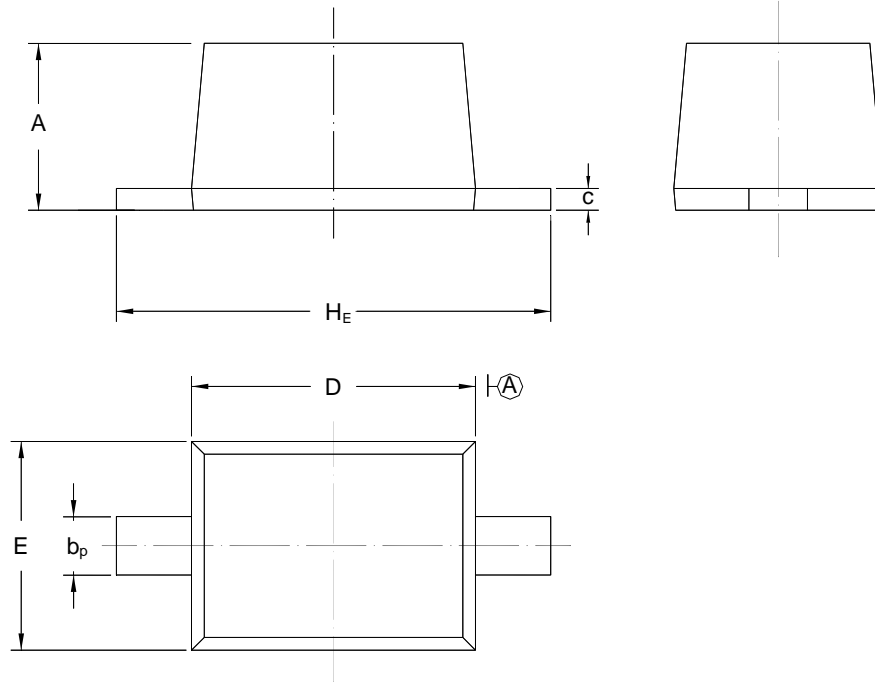

UNIT	A	b _p	C	D	E	H _E
mm	1.10 0.80	0.40 0.25	0.15 0.10	1.80 1.60	1.35 1.15	2.80 2.30

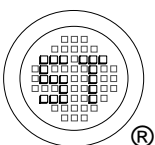

SEMTECH ELECTRONICS LTD.
Subsidiary of Sino-Tech International (BVI) Limited



Dated : 01/09/2006