

BAV70WS

Silicon Epitaxial Planar Switching Diode

PINNING

PIN	DESCRIPTION
1	Cathode
2	Anode

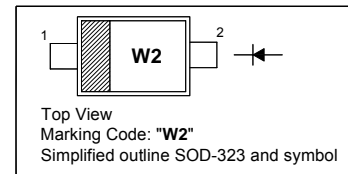

Absolute Maximum Ratings ($T_a = 25\text{ }^\circ\text{C}$)

Parameter	Symbol	Value	Unit
Peak Repetitive Reverse Voltage	V_{RRM}	70	V
Average Rectified Forward Current	$I_{F(AV)}$	200	mA
Non-Repetitive Peak Forward Current	I_{FSM}	2 1	A
		$t = 1\ \mu\text{s}$ $t = 1\ \text{s}$	
Power Dissipation	P_d	250	mW
Operating Junction Temperature Range	T_j	150	$^\circ\text{C}$
Storage Temperature Range	T_{stg}	- 55 to + 150	$^\circ\text{C}$

Characteristics at $T_a = 25\text{ }^\circ\text{C}$

Parameter	Symbol	Min.	Max.	Unit
Reverse Voltage at $I_R = 100\ \mu\text{A}$	V_R	70	-	V
Forward Voltage at $I_F = 1\ \text{mA}$ at $I_F = 10\ \text{mA}$ at $I_F = 50\ \text{mA}$	V_F	- - -	715 855 1	mV mV V
Reverse Voltage at $V_R = 70\ \text{V}$ at $V_R = 25\ \text{V}$, $T_a = 150\text{ }^\circ\text{C}$ at $V_R = 70\ \text{V}$, $T_a = 150\text{ }^\circ\text{C}$	I_R	- - -	5 60 100	μA
Reverse Recovery Time at $I_F = I_R = 10\ \text{mA}$ to $I_R = 1\ \text{mA}$, $R_L = 100\ \Omega$	t_{rr}	-	6	ns
Total Capacitance at $V_R = 0$, $f = 1\ \text{MHz}$	C_T	-	1.5	pF

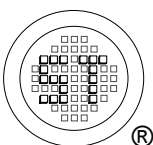

SEMTECH ELECTRONICS LTD.
Subsidiary of Sino-Tech International (BVI) Limited



Dated : 15/06/2009

BAV70WS

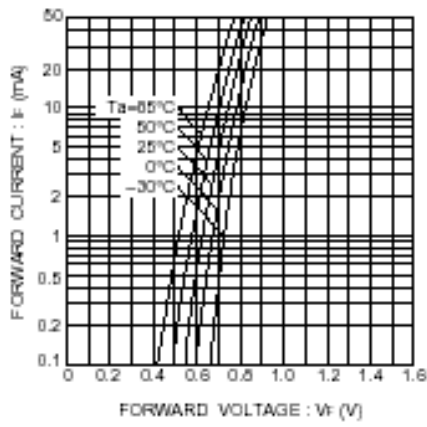

Forward characteristics

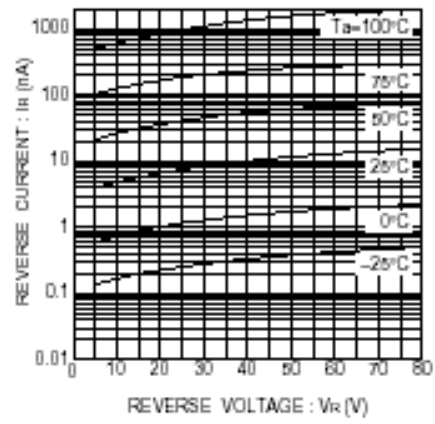

Reverse characteristics

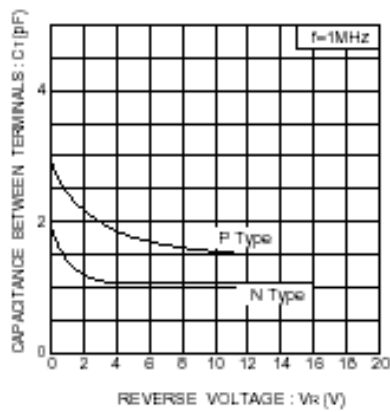

Capacitance between terminals characteristics

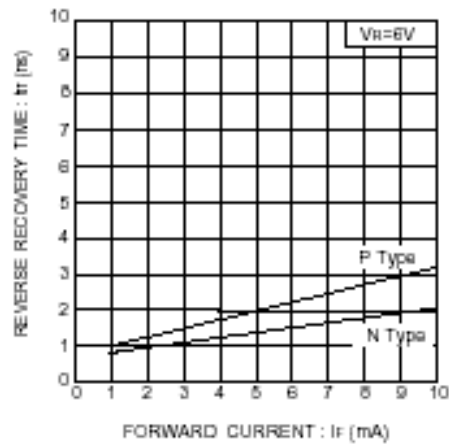

Reverse recovery time

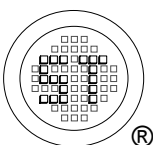

SEMTECH ELECTRONICS LTD.
Subsidiary of Sino-Tech International (BVI) Limited



Dated : 15/06/2009

BAV70WS

PACKAGE OUTLINE

Plastic surface mounted package; 2 leads

SOD-323

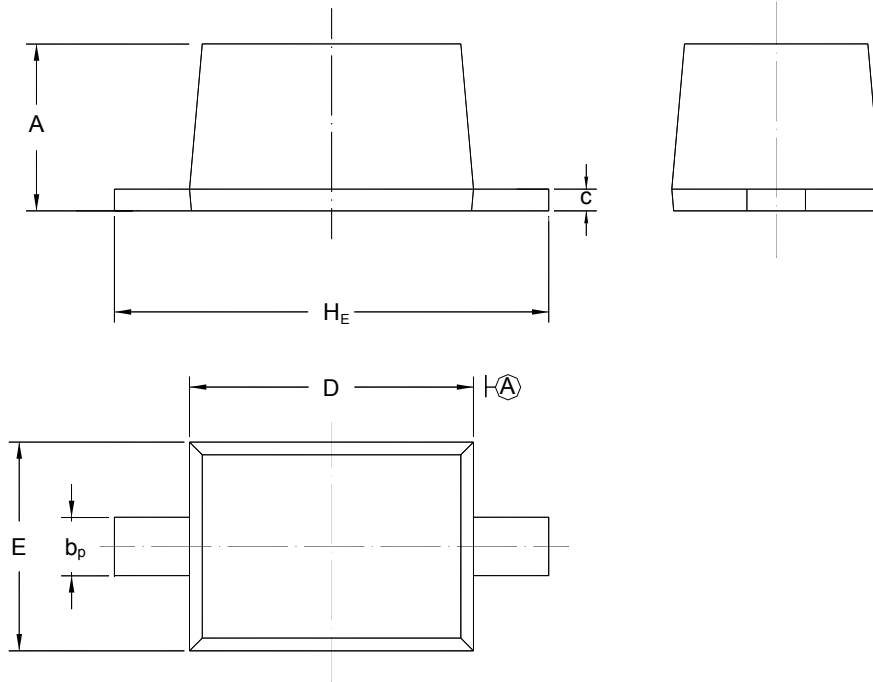

UNIT	A	b_p	C	D	E	H_E
mm	1.10 0.80	0.40 0.25	0.15 0.10	1.80 1.60	1.35 1.15	2.80 2.30

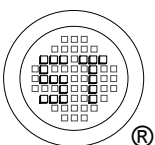

SEMTECH ELECTRONICS LTD.
Subsidiary of Sino-Tech International (BVI) Limited



Dated : 15/06/2009