

BAS16WS

Silicon Epitaxial Planar Switching Diode

Features

- Fast switching diode

PINNING

PIN	DESCRIPTION
1	Cathode
2	Anode

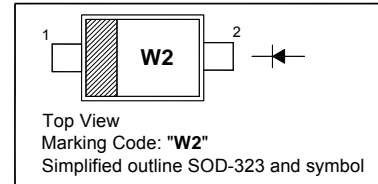

Absolute Maximum Ratings ($T_a = 25\text{ }^\circ\text{C}$)

Parameter	Symbol	Value	Unit
Reverse Voltage	V_R	75	V
Peak Reverse Voltage	V_{RM}	100	V
Forward Current (Continuous)	I_F	250	mA
Non-repetitive Peak Forward Surge Current	I_{FSM}	at $t = 1\text{ s}$ 0.5	A
		at $t = 1\text{ ms}$ 1	
		at $t = 1\text{ }\mu\text{s}$ 2	
Power Dissipation	P_{tot}	200	mW
Junction Temperature	T_j	150	$^\circ\text{C}$
Storage Temperature Range	T_{stg}	- 65 to + 150	$^\circ\text{C}$

Characteristics at $T_a = 25\text{ }^\circ\text{C}$

Parameter	Symbol	Max.	Unit				
Forward Voltage at $I_F = 1\text{ mA}$ at $I_F = 10\text{ mA}$ at $I_F = 50\text{ mA}$ at $I_F = 150\text{ mA}$	V_F	0.715 0.855 1 1.25	V				
Reverse Leakage Current at $V_R = 75\text{ V}$ at $V_R = 25\text{ V}$, $T_J = 150\text{ }^\circ\text{C}$ at $V_R = 75\text{ V}$, $T_J = 150\text{ }^\circ\text{C}$		I_R		1 30 50	μA		
Diode Capacitance at $V_R = 0\text{ V}$, $f = 1\text{ MHz}$				C_{tot}		2	pF
Reverse Recovery Time at $I_F = 10\text{ mA}$ to $I_R = 10\text{ mA}$, $I_R = 1\text{ mA}$, $R_L = 100\text{ }\Omega$				t_{rr}		6	ns

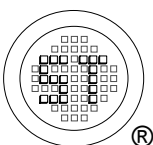

SEMTECH ELECTRONICS LTD.
Subsidiary of Sino-Tech International (BVI) Limited



Dated : 15/06/2009

BAS16WS

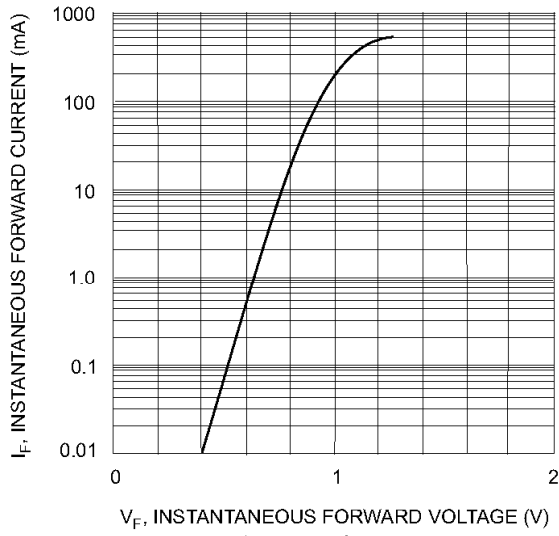

Fig. 1 Forward Characteristics

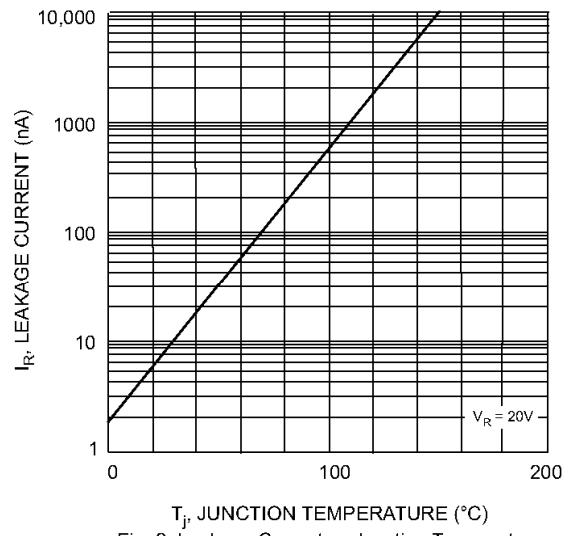
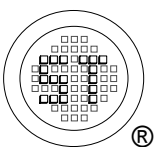

Fig. 2 Leakage Current vs Junction Temperature



SEMTECH ELECTRONICS LTD.
 Subsidiary of Sino-Tech International (BVI) Limited



Dated : 15/06/2009

BAS16WS

PACKAGE OUTLINE

Plastic surface mounted package; 2 leads

SOD-323

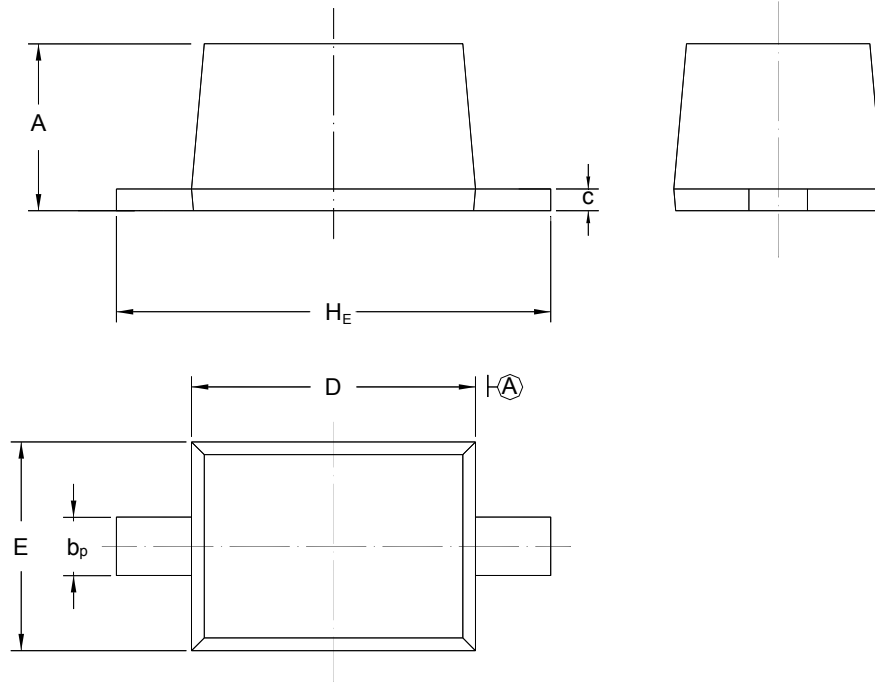

UNIT	A	b _p	C	D	E	H _E
mm	1.10 0.80	0.40 0.25	0.15 0.10	1.80 1.60	1.35 1.15	2.80 2.30

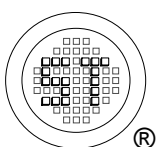

SEMTECH ELECTRONICS LTD.
Subsidiary of Sino-Tech International (BVI) Limited



Dated : 15/06/2009