

# 1SS368

## Silicon Epitaxial Planar Switching Diode

### Features

- Small package
- Low forward voltage
- Fast reverse recovery time
- Small total capacitance

### Applications

- Ultra high speed switching

### PINNING

PIN	DESCRIPTION
1	Cathode
2	Anode

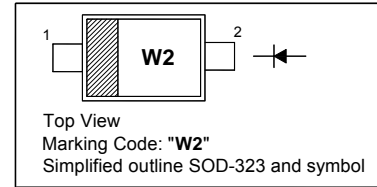

### Absolute Maximum Ratings ( $T_a = 25\text{ }^\circ\text{C}$ )

Parameter	Symbol	Value	Unit
Maximum (Peak) Reverse Voltage	$V_{RM}$	85	V
Reverse Voltage	$V_R$	80	V
Average Rectified Forward Current	$I_{F(AV)}$	100	mA
Maximum (Peak) Forward Current	$I_{FM}$	200	mA
Surge Forward Current (10 ms)	$I_{FSM}$	1	A
Power Dissipation	$P_{tot}$	150	mW
Junction Temperature	$T_j$	150	$^\circ\text{C}$
Storage Temperature Range	$T_{stg}$	- 55 to + 150	$^\circ\text{C}$

### Characteristics at $T_a = 25\text{ }^\circ\text{C}$

Parameter	Symbol	Max.	Unit
Forward Voltage at $I_F = 100\text{ mA}$	$V_F$	1.2	V
Reverse Current at $V_R = 30\text{ V}$ at $V_R = 80\text{ V}$	$I_R$	0.1 0.5	$\mu\text{A}$
Total Capacitance at $V_R = 0$ , $f = 1\text{ MHz}$	$C_T$	3	pF
Reverse Recovery Time at $I_F = I_R = 10\text{ mA}$ , $I_{rr} = 0.1 \times I_R$ , $R_L = 100\ \Omega$	$t_{rr}$	4	ns

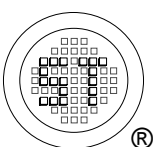

**SEMTECH ELECTRONICS LTD.**  
Subsidiary of Sino-Tech International (BVI) Limited



Dated : 07/10/2009

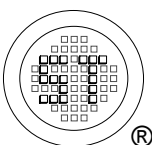
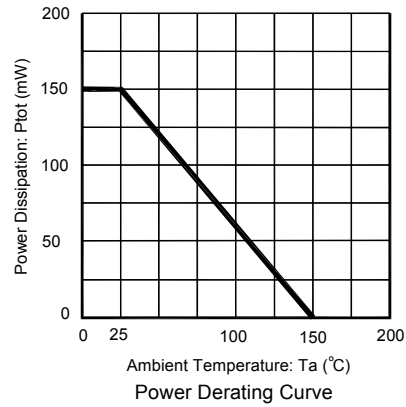
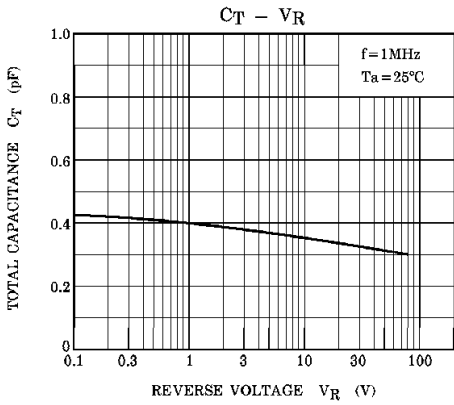
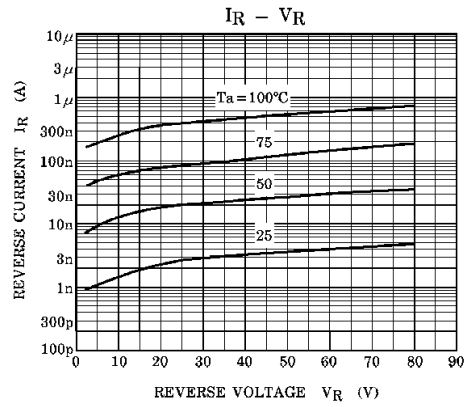
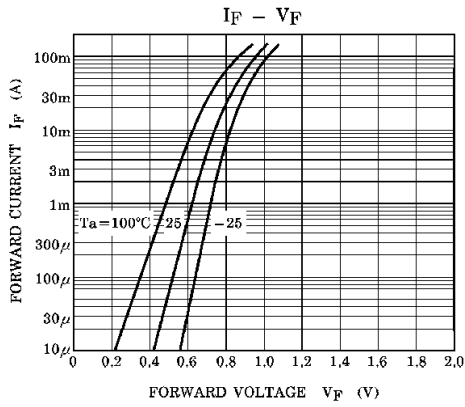

**SEMTECH ELECTRONICS LTD.**  
Subsidiary of Sino-Tech International (BVI) Limited



## PACKAGE OUTLINE

Plastic surface mounted package; 2 leads

SOD-323

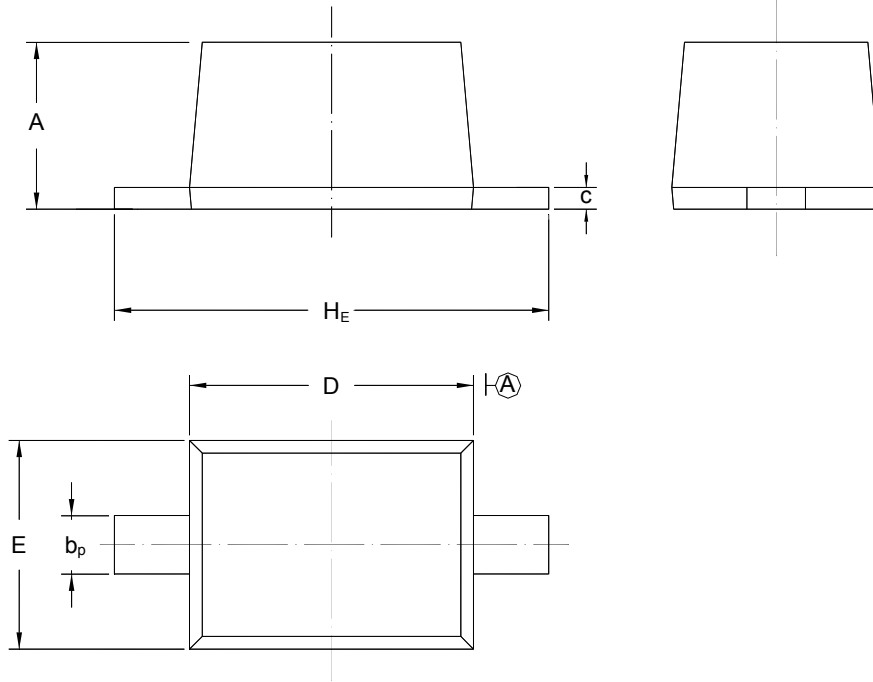

UNIT	A	$b_p$	C	D	E	$H_E$
mm	1.10 0.80	0.40 0.25	0.15 0.10	1.80 1.60	1.35 1.15	2.80 2.30

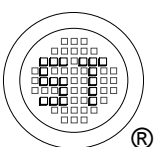

**SEMTECH ELECTRONICS LTD.**  
Subsidiary of Sino-Tech International (BVI) Limited



Dated : 07/10/2009