

# 1SS369

## SILICON EPITAXIAL SCHOTTKY BARRIER DIODE

### Features

- Low forward voltage
- Low reverse current

### Applications

- High Speed Switching

### PINNING

PIN	DESCRIPTION
1	Cathode
2	Anode

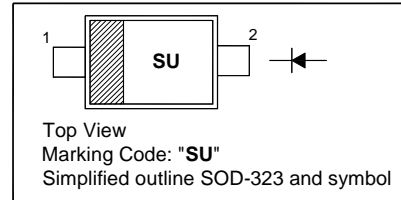

### Absolute Maximum Ratings ( $T_a = 25\text{ }^\circ\text{C}$ )

Parameter	Symbol	Value	Unit
Maximum (Peak) Reverse Voltage	$V_{RM}$	45	V
Reverse Voltage	$V_R$	40	V
Average Forward Current	$I_O$	100	mA
Maximum (Peak) Forward Current	$I_{FM}$	300	mA
Surge Forward Current (10 ms)	$I_{FSM}$	1	A
Power Dissipation	$P_{tot}$	150	mW
Junction Temperature	$T_J$	125	$^\circ\text{C}$
Operating Temperature Range	$T_{opr}$	- 40 to + 100	$^\circ\text{C}$
Storage Temperature Range	$T_{stg}$	- 55 to + 125	$^\circ\text{C}$

### Characteristics at $T_a = 25\text{ }^\circ\text{C}$

Parameter	Symbol	Max.	Unit
Forward Voltage at $I_F = 100\text{ mA}$	$V_F$	0.6	V
Reverse Current at $V_R = 40\text{ V}$	$I_R$	5	$\mu\text{A}$
Total Capacitance at $f = 1\text{ MHz}$	$C_T$	25	pF

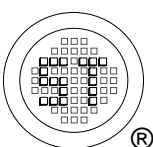

**SEMTECH ELECTRONICS LTD.**  
Subsidiary of Sino-Tech International (BVI) Limited



Dated : 01/09/2006

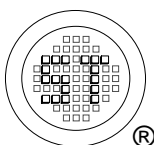
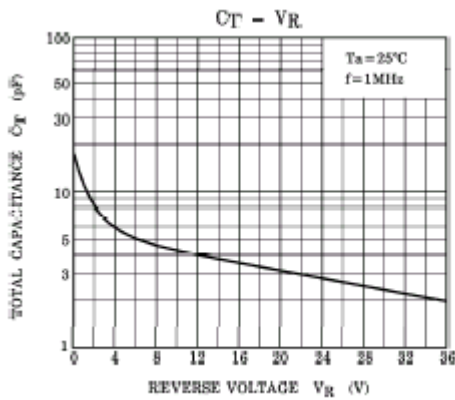
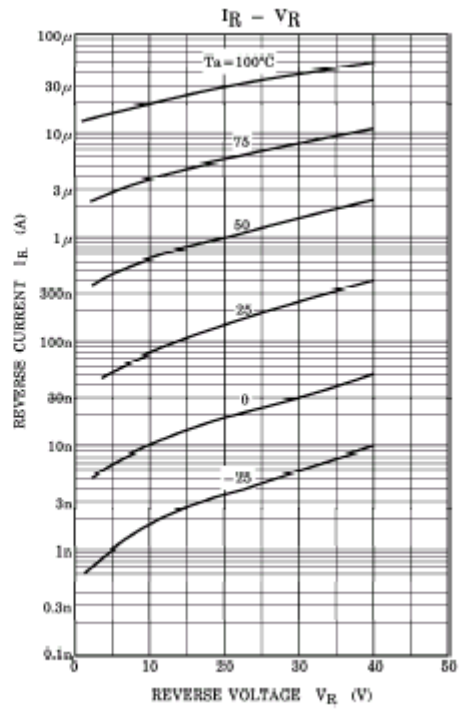
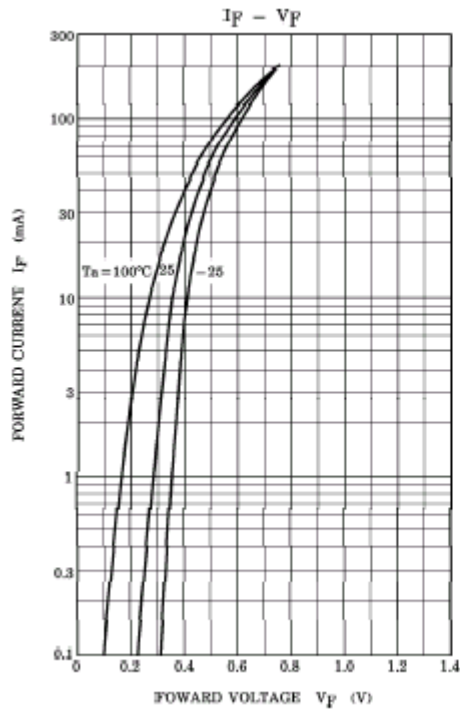

**SEMTECH ELECTRONICS LTD.**  
Subsidiary of Sino-Tech International (BVI) Limited



## PACKAGE OUTLINE

Plastic surface mounted package; 2 leads

SOD-323

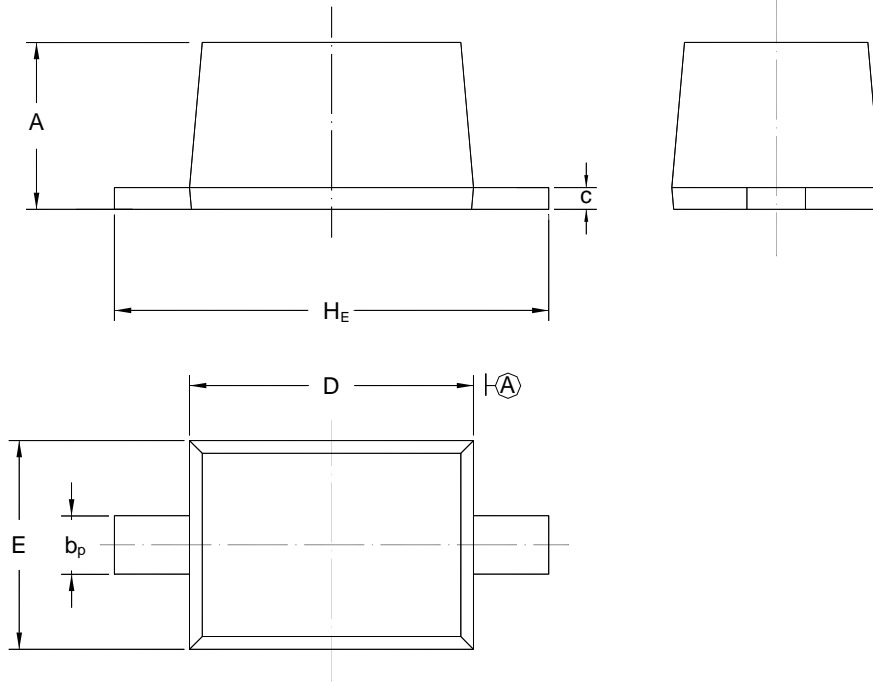

UNIT	A	b <sub>p</sub>	C	D	E	H <sub>E</sub>
mm	1.10 0.80	0.40 0.25	0.15 0.10	1.80 1.60	1.35 1.15	2.80 2.30

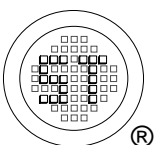

**SEMTECH ELECTRONICS LTD.**  
Subsidiary of Sino-Tech International (BVI) Limited



Dated : 01/09/2006