

# MBR0530

## Surface Mount Schottky Barrier Diode

### PINNING

PIN	DESCRIPTION
1	Cathode
2	Anode

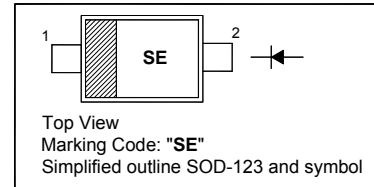

### Absolute Maximum Ratings ( $T_a = 25^\circ\text{C}$ )

Parameter	Symbol	Value	Unit
Repetitive Peak Reverse Voltage	$V_{RRM}$	30	V
Non-Repetitive Peak Reverse Voltage	$V_{RSM}$	30	V
Maximum DC Blocking Voltage	$V_R$	30	V
Average Forward Rectified Current	$I_{F(AV)}$	0.5	A
Peak Forward Surge Current (8.3 ms Single Half Sine-wave)	$I_{FSM}$	5.5	A
Thermal Resistance Junction to Lead	$R_{\theta JL}$	150	$^\circ\text{C/W}$
Thermal Resistance Junction to Ambient <sup>1)</sup>	$R_{\theta JA}$	206	$^\circ\text{C/W}$
Operating Junction Temperature	$T_j$	- 65 to + 125	$^\circ\text{C}$
Storage Temperature Range	$T_{stg}$	- 65 to + 125	$^\circ\text{C}$

<sup>1)</sup> 1 inch square pad size (1 X 0.5 inch for each lead) on FR4 board

### Characteristics at $T_a = 25^\circ\text{C}$

Parameter	Symbol	Max.	Unit
Forward Voltage at $I_F = 100\text{ mA}$ at $I_F = 500\text{ mA}$	$V_F$	0.375 0.5	V
Reverse Current at $V_R = 30\text{ V}$ at $V_R = 15\text{ V}$	$I_R$	130 20	$\mu\text{A}$

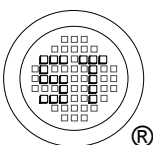

**SEMTECH ELECTRONICS LTD.**  
Subsidiary of Sino-Tech International (BVI) Limited



Dated : 27/09/2010 Rev:01

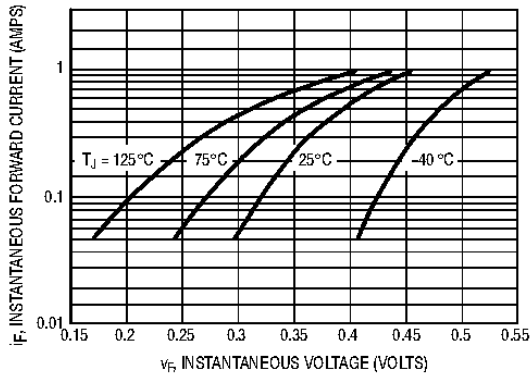

Figure 1. Typical Forward Voltage

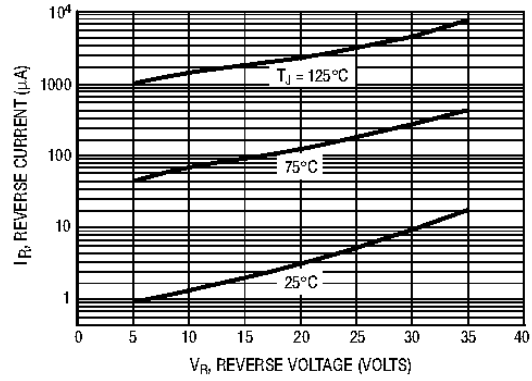

Figure 2. Typical Reverse Current

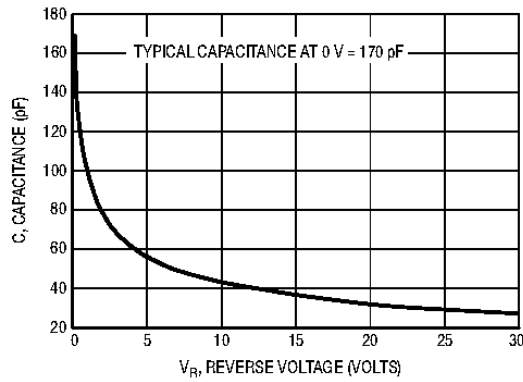
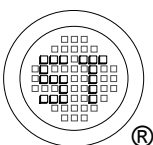

Figure 3. Typical Capacitance



# MBR0530

## PACKAGE OUTLINE

Plastic surface mounted package; 2 leads

SOD-123

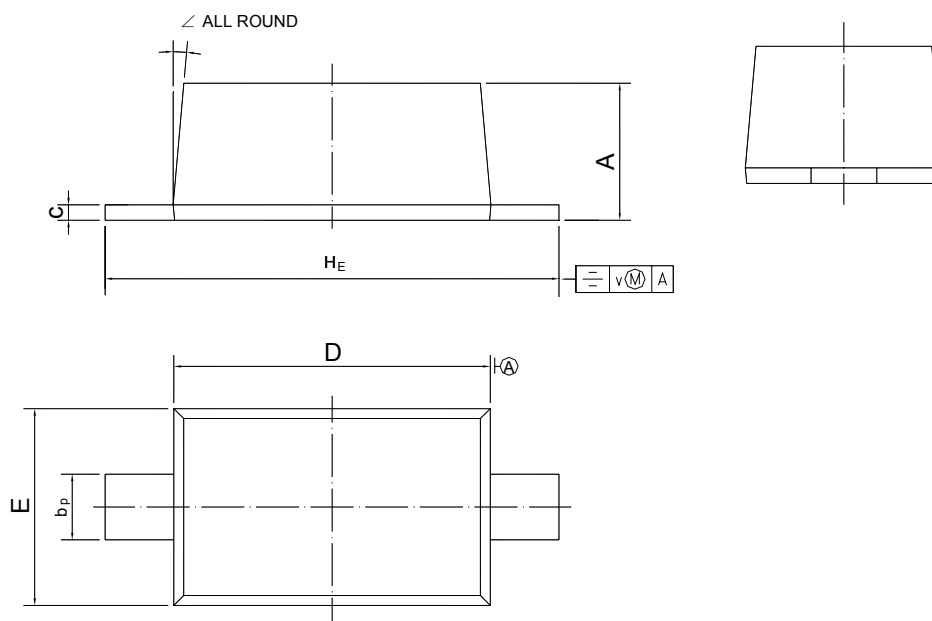

UNIT	A	b <sub>p</sub>	c	D	E	H <sub>E</sub>	v	∠
mm	1.15 1.05	0.6 0.5	0.135 0.100	2.7 2.6	1.65 1.55	3.85 3.55	0.2	5°

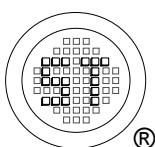

**SEMTECH ELECTRONICS LTD.**  
Subsidiary of Sino-Tech International (BVI) Limited



Dated : 27/09/2010 Rev:01