

TAPING SPECIFICATIONS 編帶標準

□ For Chip Type Aluminum Electrolytic Capacitors 貼片式鋁電解電容器

■ Carrier Tape 載帶

● Drawing 1 (for $\varnothing 4 \sim \varnothing 10$) 外形圖 1

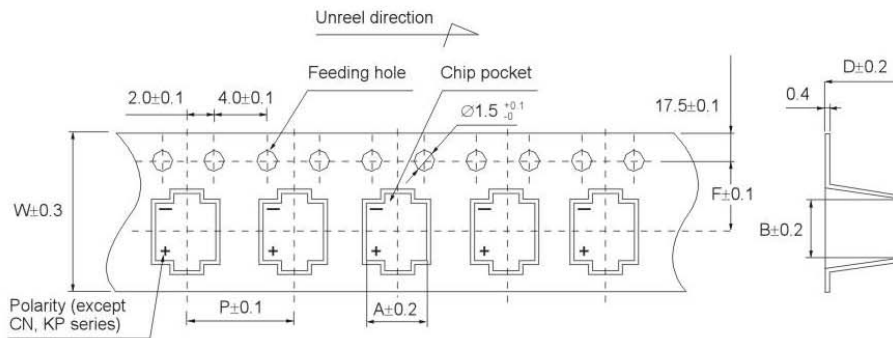

Dimension 尺寸表

(Unit: mm)

$\varnothing D \times L$	4x5.4/5.8	5x5.4/5.8	6.3x5.4/5.8	6.3x7.7	8x6.2	8x10.5	10x10.5/13.5
W	12.0	12.0	16.0	12.0	16.0	24.0	24.0
P	8.0	12.0	12.0	12.0	12.0	16.0	16.0
F	5.5	5.5	7.5	7.5	7.5	11.5	11.5
A	5.0	6.0	7.0	7.0	8.7	8.7	10.7
B	5.0	6.0	7.0	7.0	8.7	8.7	10.7
D	5.8/6.3	5.8/6.3	5.8/6.3	8.4	6.8	11.0	11.0/14.0

● Drawing 2 (for $\varnothing 12.5 \sim \varnothing 16$) 外形圖 2

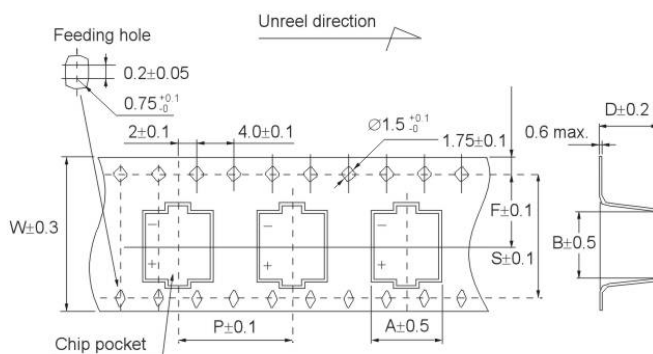

Dimension 尺寸表

(Unit: mm)

$\varnothing D \times L$	12.5x13.5	12.5x16	16x16.5/21.5
W	32.0	32.0	44.0
P	24.0	24.0	28.0
F	14.2	14.2	20.2
A	14.0	14.0	17.5
B	14.0	14.0	17.5
D	14.0	16.5	17.5/22.5
S	28.4	28.4	40.4

NOTE: All designs and specifications are for reference only and are subject to change without prior notice. If any doubt about safety for your application, please contact us immediately for technical assistance before purchase.

注：以上所提供的設計及特性參數僅供參考作用，任何修改不作預先通知。如果在使用上有疑問，請在採購前與我們聯絡，以便提供技術上的協助。

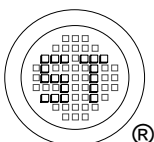

SEMTECH ELECTRONICS LTD.

(Subsidiary of Sino-Tech International Holdings Limited, a company listed on the Hong Kong Stock Exchange, Stock Code: 724)

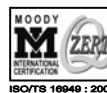

■ Reel 卷盤

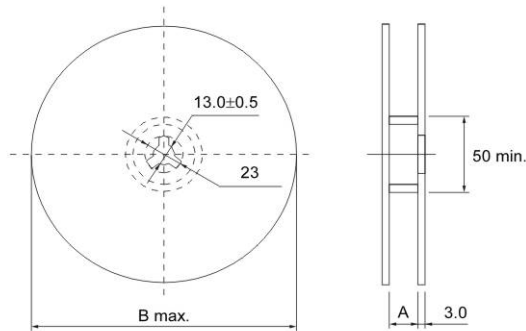

(Unit: mm)

∅D×L	4×5.4/5.8	5×5.4/5.8	6.3×5.4/5.8/7.7	8×6.2/10.5	10×10.5	10×13.5	12.5×13.5/16	16×16.5
A	14	14	18	26	26	26	34	46
B	382	382	382	382	382	382/332*	382/332*	332*

*For a small package *為小盤包裝

■ In-box 內盒

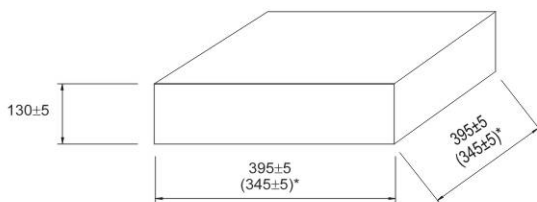

■ Package Quantity 包裝數量

(Unit: mm)

Size (∅D×L) 尺寸	Reel (pcs) 卷盤 (個)	In-box (reels) 內盒 (卷)	Quantity/In-box (pcs) 數量/內盒 (個)	4 In-boxes/Carton (pcs) 4 個內盒/箱 (個)
4 × 5.5/5.8	2,000	6	12,000	48,000
5 × 5.4/5.8	1,000	6	6,000	24,000
6.3 × 5.4/5.8	1,000	5	5,000	20,000
6.3 × 7.7	1,000	5	5,000	20,000
8 × 6.2	1,000	5	5,000	20,000
8 × 10.5	500	4	2,000	8,000
10 × 10.5	500	4	2,000	8,000
10 × 13.5	300/250*	4	1,200/1,000*	4,800/4000*
12.5 × 13.5	200/150*	3	600/450*	2,400/1,800*
12.5 × 16	200/150*	3	600/450*	2,400/1,800*
16 × 16.5	125*	2	250*	1,000*

*For a small package *為小盤包裝

NOTE: All designs and specifications are for reference only and are subject to change without prior notice. If any doubt about safety for your application, please contact us immediately for technical assistance before purchase.

注：以上所提供的設計及特性參數僅供參考作用，任何修改不作預先通知。如果在使用上有疑問，請在採購前與我們聯絡，以便提供技術上的協助。

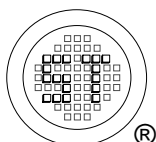

SEMTECH ELECTRONICS LTD.

(Subsidiary of Sino-Tech International Holdings Limited, a company listed on the Hong Kong Stock Exchange, Stock Code: 724)

